

spec[®]

Standard Performance Evaluation Corporation (SPEC[®])

SERT[®] Suite User Guide 2.0.5

7001 Heritage Village Plaza, Suite 225
Gainesville, VA 20155,
USA

Table of Contents

1. Overview	4
1.1. Summary.....	4
1.2. Trademark and Copyright Notice.....	4
2. Setup Requirements	5
2.1. SERT Suite Installation	6
3. Starting the SERT suite via the Graphical User Interface (GUI).....	7
3.1. Prerequisites for Using the GUI	7
3.1.1. On the SUT and Controller system.....	7
3.1.2. On the SUT only	7
3.1.3. On the Controller system only:.....	7
3.2. Invoking the GUI.....	7
3.3. Interacting with the GUI	8
3.3.1. Start	8
3.3.2. SUT Configuration	9
3.3.3. SUT Discovery	10
3.3.4. Test Environment.....	11
3.3.5. PTDaemon® Configuration.....	13
3.3.6. JVM Configuration	19
3.3.7. JVM Review.....	20
3.3.8. Choose Test Suite.....	21
3.3.9. Launch Test	23
3.3.10. Results.....	25
3.3.11. Help.....	26
4. Platform Specific Settings.....	27
4.1. Microsoft Windows Server 2012, 2016, 2019	27
4.1.1. Lock Pages in Memory	27
4.1.2. Disabling the storage write cache.....	27
4.1.3. Disabling the Windows firewall	28
4.1.4. Open firewall port for the SERT Suite	28
4.1.5. Windows 2008 R2 Systems with > 64 logical processors.....	29
4.1.6. Windows Server Hyper-V.....	29
4.1.7. Windows Server and OpenJDK 11.....	29
4.2. Linux	30
4.2.1. Prerequisite Software	30
4.2.2. Enabling Transparent Huge Pages (THP).....	30
4.2.3. Disabling the storage write cache on Linux	30
4.2.4. Disabling the firewall	30
4.2.5. Open firewall port for the SERT Suite	31
4.2.6. Linux on IBM Power Systems	31
4.3. IBM AIX.....	32

- 4.3.1. Disabling the AIX firewall32
- 5. Power Analyzer Range Settings 33**
 - 5.1. Automating Range Settings using the GUI33
 - 5.2. Manual Range Settings – Optional33
- 6. The SERT Suite Command Line Usage..... 34**
 - 6.1. The SERT Suite Configuration and Start Procedure.....34
 - 6.2. Generate report files with the reporter scripts36
- 7. General Troubleshooting 38**
 - 7.1. Using the Collector Scripts38
 - 7.2. WARNING/INVALID Messages.....39
 - 7.2.1. Power Analyzer39
 - 7.2.2. Coefficient of Variation (CV)39
 - 7.2.3. Transactions per second was xx% of target40

This document version: <https://www.spec.org/sert2/SERT-userguide-20220223.pdf>
This document version in Mandarin: <https://www.spec.org/sert2/SERT-userguide-20220223-zh.pdf>
Latest SERT 2.x.x version: <https://www.spec.org/sert2/SERT-userguide.pdf>
Previous version: <https://www.spec.org/sert2/SERT-userguide-20210331.pdf>

1. Overview

The SERT Suite was created by the Standard Performance Evaluation Corporation (SPEC®), the world's leading organization for benchmarking expertise. The SPECpower Committee designed, implemented, and delivered the SERT Suite, a next-generation tool set for measuring and evaluating the energy efficiency of servers. The SERT Suite was created with input from leaders of various global energy-efficiency programs and their stakeholders in order to accommodate their regional program requirements.

1.1. Summary

This User Guide is intended for both novice and experienced SERT users. Chapter 2 describes the hardware and software requirements for the SERT environment necessary for measuring a compliant SERT run. Step-by-step instructions for running SERT Suite via the GUI can be found in chapter 3. The following chapter provides information on platform-specific configuration such as modifying firewall settings and disabling storage caches. Chapter 5 describes methods for setting the correct current and voltage ranges for your power analyzer. For the advanced user, chapter 6 explains how to setup and run the SERT suite from the command line. The User Guide concludes in chapter 7 with guidance on troubleshooting.

The SERT Run and Reporting Rules (<https://www.spec.org/sert2/SERT-runrules.pdf>) describe the rules that need to be followed in order to create a compliant SERT run. Further background information describing the design and implementation of the SERT Suite can be found in the SERT Design Document (<https://www.spec.org/sert2/SERT-designdocument.pdf>).

1.2. Trademark and Copyright Notice

SPEC, the SPEC logo, and the names PTDaemon, SERT, and Chauffeur are registered trademarks of the Standard Performance Evaluation Corporation (SPEC). Additional product and service names mentioned herein may be the trademarks of their respective owners. Copyright © 1988-2022 Standard Performance Evaluation Corporation (SPEC). All rights reserved.

2. Setup Requirements

For the most basic SERT setup, the following hardware is required:

- System under Test (**SUT**): the actual system for which the measurements are being taken
 - For the list of supported platforms, please see the SERT Client configuration guide: https://www.spec.org/sert2/SERT-JVM_Options-2.0.html.
 - For memory requirements, please see Section 2.4.3 Memory the SERT Run and Reporting Rules.
 - For network requirements, please see Section 2.4.4 Network the SERT Run and Reporting Rules.
 - For storage requirements, please see Section 2.4.5 Storage in the SERT Run and Reporting Rules.
 - For software requirements, please see Section 2.4.6 Software the SERT Run and Reporting Rules.
- One **Controller**: The system is connected to the power analyzer, temperature sensor and SUT.
- At least one **power analyzer** connected to the Controller and the SUT's power supply to measure and record the SUT's power consumption.
- One **temperature sensor** connected to the Controller which is placed in front of the SUT's main airflow inlet to measure the ambient temperature.
- The SERT Suite can only use power analyzers and temperature sensors in the list of acceptable measurement devices (https://www.spec.org/power/docs/SPECpower-Device_List.html).

The date, time and time zone of the SUT and controller must be set correctly.

The controller and SUT are interconnected via Ethernet, as shown in the block diagram below, which represents a simple SERT environment.

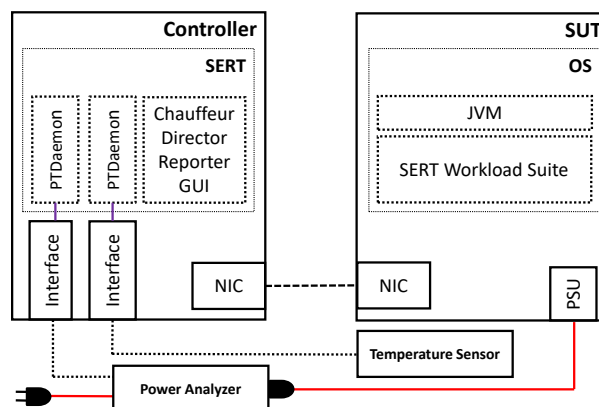

Figure 1: SERT Environment

Note: Before connecting the power analyzer and the temperature sensor to the Controller and the SUT, please read the “Power and Temperature Measurement Setup Guide” in the Documentation directory on the SERT media carefully! The latest version of this document can be found on the SPEC web site (https://www.spec.org/power/docs/SPEC-Power_Measurement_Setup_Guide.pdf). This practical guide explains how to set up and run various power analyzers and temperature sensors with the SPEC PTDaemon® Interface.

Note: This release of the SERT Suite is only intended to be used with servers running on AC power. DC power measurement is currently not supported.

2.1. SERT Suite Installation

Ensure that a Java runtime environment (SERT 2.0.5 requirement: Java 8 or higher) is already installed on the SUT and the Controller. Start the SERT setup via `java -jar SERT-2.0.5-setup.jar` and follow the instructions on the screen. Ensure that the SERT suite is installed on the OS partition for both SUT and Controller.

Installing the SERT distribution media will create a directory tree of files and subdirectories.

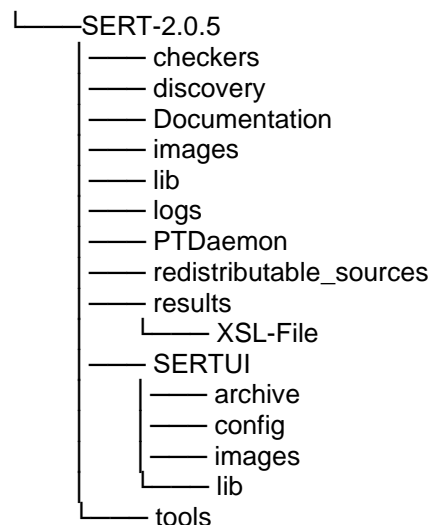

This document can be found in the `Documentation` directory, while the various script and batch files discussed in the following sections are present in the `SERT` directory or the `PTDaemon` sub-directory. If the user will be using multiple machines to perform a SERT measurement sequence, it will be necessary to unpack (or install) all the files onto the storage devices which hold the operating system image on each system.

3. Starting the SERT Suite via the Graphical User Interface (GUI)

The SERT GUI provides an intuitive way for the user to configure and run a test, and to view and archive the results of those tests.

3.1. Prerequisites for Using the GUI

The instructions below assume that the GUI will be running on the Controller system, and that the SUT is a separate host.

3.1.1. On the SUT and Controller system

Ensure that the firewall is disabled; see section 4 for platform specific instructions.

To avoid collecting non relevant information from previous runs the SERT package includes two additional scripts also to be found in the base SERT installation directory:

`cleanlogfiles.bat` is intended to remove log files from previous runs on a Microsoft Windows Operating System.

`cleanlogfiles.sh` is intended to remove log files from previous runs on a Linux/UNIX system.

It is strongly recommended to execute these scripts each time before starting a new SERT cycle, to ensure only relevant log files from the current cycle are archived.

3.1.2. On the SUT only

If applicable, please follow the platform specific settings in section 4.

Set the `JAVA` variable in the `serthost.sh/.bat` script to the java executable the SERT suite should use. For example:

- For `serthost.bat`:
 - o `set JAVA="C:\Program Files\Java\jre1.8.0_321\bin\java.exe"`
- For `serthost.sh`:
 - o `JAVA=/usr/java/jre1.8.0_321/bin/java`

Run the `serthost.bat/.sh` script file. On Windows, this should run as an Administrator. On Linux, it should run as root. With Ubuntu (or other Linux distributions where a root login is not normally available), use "`sudo serthost.sh`".

3.1.3. On the Controller system only

The default heap space for the director is 2GB (`-Xmx2048m`) which has been sufficient for environments with up to 8 nodes / 704 total cores. Larger environments may require an additional 256 MB heap space for every 100 cores.

The director heap size can be adjusted by setting the `-Xmx` parameter in the `JAVAOPTIONS_DIRECTOR` variable in the `director.sh/.bat` script, the default command is:

```
set JAVAOPTIONS_DIRECTOR=-Xms64m -Xmx2048m -Djava.util.logging.config.file=logging.properties
```

Adjustment for 12 nodes / 1056 core:

```
set JAVAOPTIONS_DIRECTOR=-Xms64m -Xmx3072m -Djava.util.logging.config.file=logging.properties
```

3.2. Invoking the GUI

Open a cmd window and run one of the scripts `SERT-2.0.5\SERTUI\run-sertui.bat` or `run-sertui.sh` depending on your operating system.

```
cd [Install directory]\SERT-2.0.5\SERTUI
run-sertui.bat
```

The command script doesn't return and will leave the window open.

3.3. Interacting with the GUI

3.3.1. Start

The **Start** panel of the GUI shows the sequence of steps necessary to run the SERT Suite.

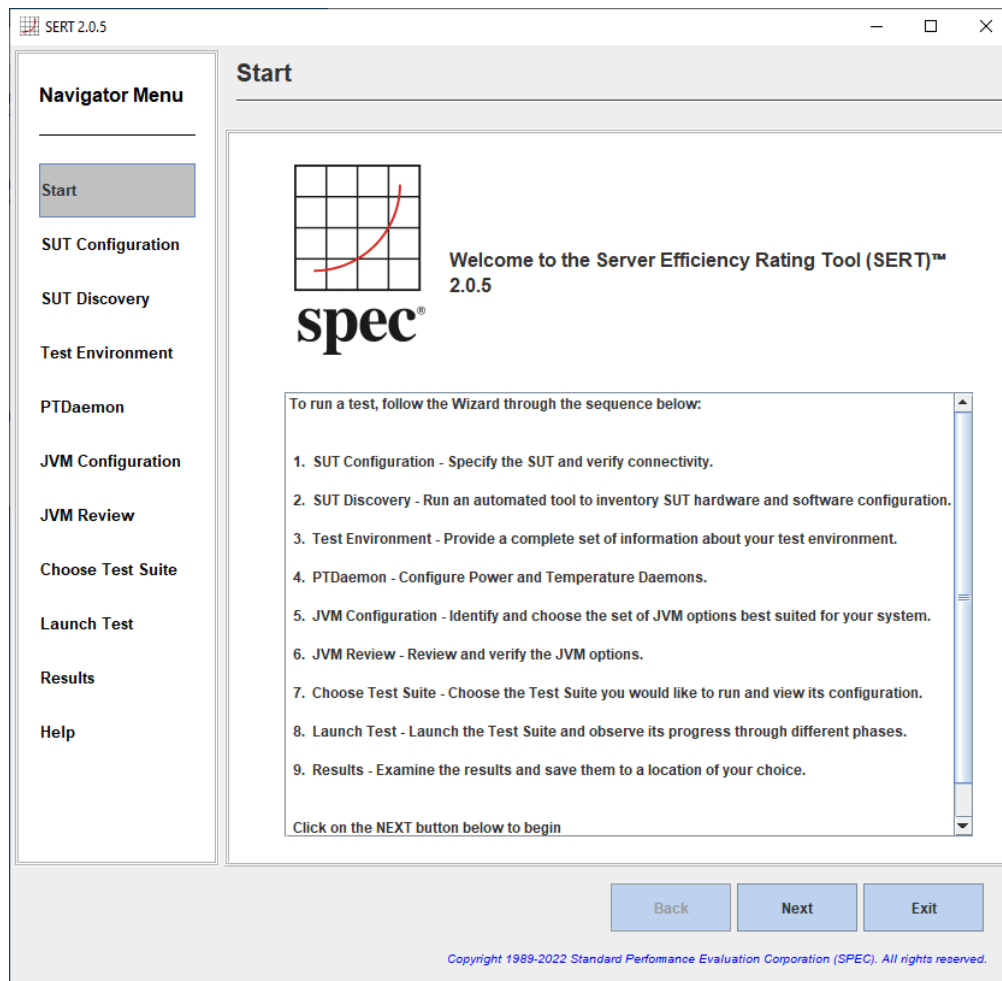

Click **Next** to continue, or **Exit** to terminate the GUI.

3.3.2. SUT Configuration

The *SUT Configuration* panel allows the user to configure the IP Address(es) or hostname of the SUT.

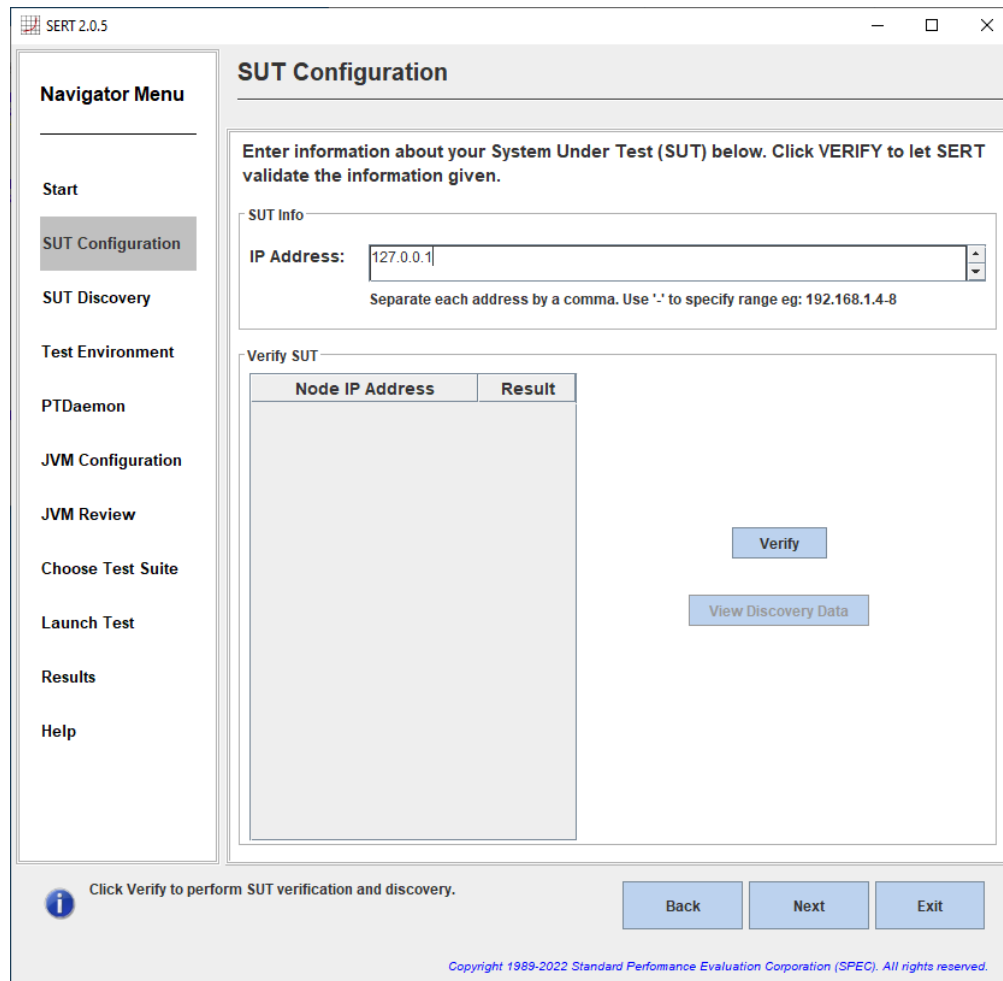

Provide the **IP Address**, multiple IP addresses can be provided via a comma-separated list (e.g. 10.0.0.101, 10.0.0.110) or by specifying an IP Address range (e.g. 10.0.0.101-120).

Click **Verify**, in order for the GUI to verify the connection to the remote service running on the SUT(s). If a failure occurs, an error message will appear in the lower left corner of the GUI.

When verification is successful, click **Next** to continue.

3.3.3. SUT Discovery

The **SUT Discovery** panel shows software and hardware configuration retrieved from the SUT. Please wait for the process to complete, after which a table of discovery items will be shown. Select the **Save** check box and click **Next** to save the configuration values into the test environment file (`test-environment.xml`). On subsequent runs, uncheck the **Save** box to bypass overwriting any configuration changes that might have been made.

If the test configuration is already correctly described in `test-environment.xml` you should deselect the **Save** check box to prevent this information being overwritten by the SERT UI.

SUT Discovery

SUT Info

Network Address : 192.168.188.61
 System Type : Windows
 SERT Install Directory : C:\SERT-2.0.5

WARNING: Discovery items are not being saved.

The following values have been automatically detected and will be copied into the test environment configuration. Deselect the below check box if you would like to keep your test environment configuration as-is, or select individual items to save.

Save Discovery items to Test Environment Configuration file.

Toggle ALL items

Save	Discover Item	Result
<input checked="" type="checkbox"/>	OSFileSystem	NTFS
<input checked="" type="checkbox"/>	BiosVersion	V5.0.0.9 R1.14.0 for D3348-A1x
<input checked="" type="checkbox"/>	NicSpeed	10000
<input checked="" type="checkbox"/>	NicSpeed	1000
<input checked="" type="checkbox"/>	NicSpeed	0
<input checked="" type="checkbox"/>	NicDescription	Hyper-V Virtual Ethernet Adapter
<input checked="" type="checkbox"/>	NicDescription	Hyper-V Virtual Switch Extension Adapter
<input checked="" type="checkbox"/>	NicDescription	Intel(R) Ethernet Connection I217-LM
<input checked="" type="checkbox"/>	NicDescription	TAP-Windows Adapter V9
<input checked="" type="checkbox"/>	NicNetEnabled	1
<input checked="" type="checkbox"/>	NicNetEnabled	1
<input checked="" type="checkbox"/>	NicNetEnabled	0
<input checked="" type="checkbox"/>	NicQuantity	1
<input checked="" type="checkbox"/>	NicQuantity	1
<input checked="" type="checkbox"/>	NicQuantity	1
<input checked="" type="checkbox"/>	NicQuantity	1
<input checked="" type="checkbox"/>	MemoryDimmSizeMB	8192
<input checked="" type="checkbox"/>	MemoryDimmQuantity	2

Discovery items are not being saved. Click NEXT to continue.

Back Next Exit

Copyright 1989-2022 Standard Performance Evaluation Corporation (SPEC). All rights reserved.

3.3.4. Test Environment

The **Test Environment** panel allows the user to provide detailed information about the hardware and software setup used to obtain the SERT results. The information as defined in the Test Environment fields will appear in the Results Report at the end of the test run. Initially, the default template is populated with sample fields to provide an example configuration. The discovery process will also populate some fields in certain sections of the test environment file. If the status of any specific section is listed as “Defaults in use” displayed with a yellow background, this means that at least one of the fields listed within this section is still using a default value which does not reflect the actual system being measured. If the status of any specific section is listed as “Incomplete” displayed with a red background, the discovery process was unable to obtain any information. In both cases the user is required to provide the specific value for this field. If a section is listed as “Complete” with a green background, this indicates that all fields within this section have been updated either through discovery value population or manual editing.

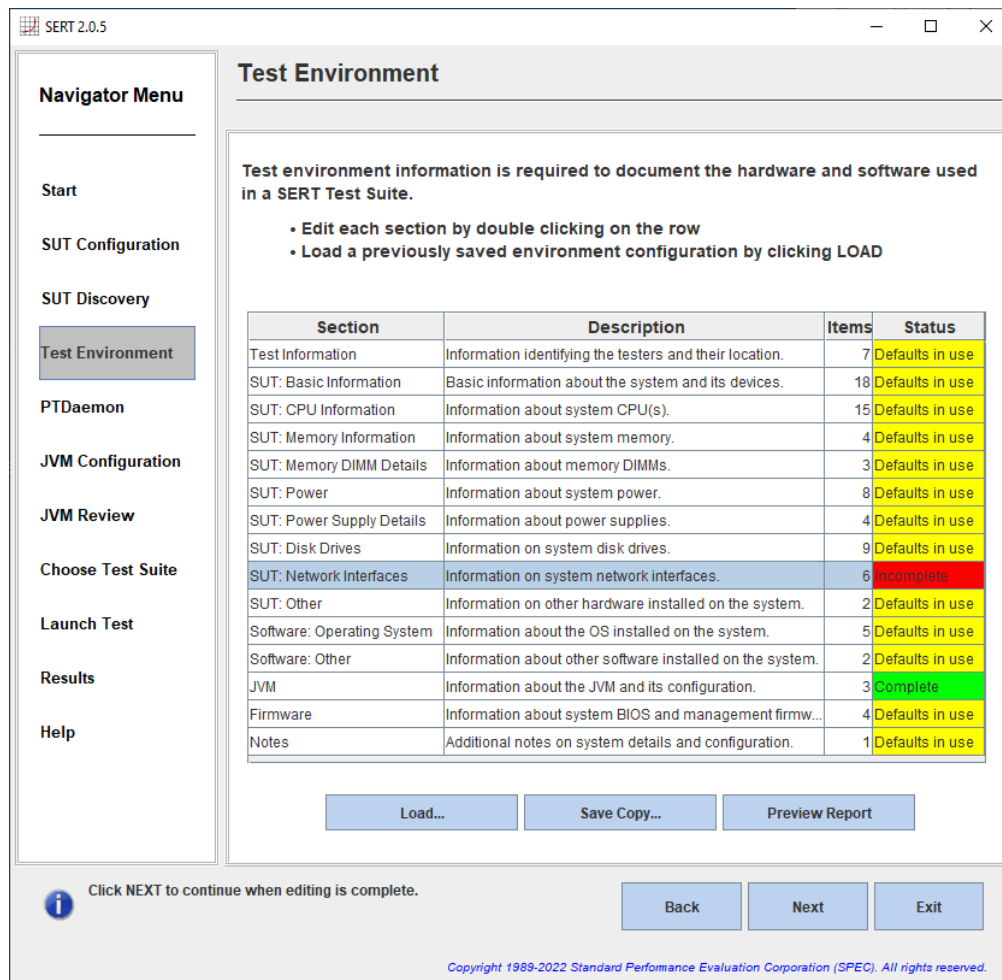

The SUT Discovery from the previous step only partially identifies the configuration. Every section needs to be checked by the user, and entries must be edited manually as appropriate. These elements must be double-checked for correctness and examined for proper formatting. Highlight a row in the table and double click to edit the information associated with that section, e.g. select the **Test Information** section.

To make changes, double click the field to be edited in the right column, change the value directly, and hit the **Return** key. On completion, click **OK** to save.

Besides changing the available entries, some test environment sections support adding new groups of items. Currently this feature is available for **SUT: Memory DIMM Details**, **SUT: Disk Drives**, **SUT: Power Supply Details**, **SUT: Network Interfaces**, **SUT: Other**, and for **Software: Other**.

Click on the **Add Group/Item** button to add a new group of items. The example in the picture below shows three new detail items for DIMM group [1]. The information in the value fields must be edited as described above. Use the **Delete** button to delete the highlighted items. Use the **OK** button to store the updated information and return to the main **Test Environment** panel.

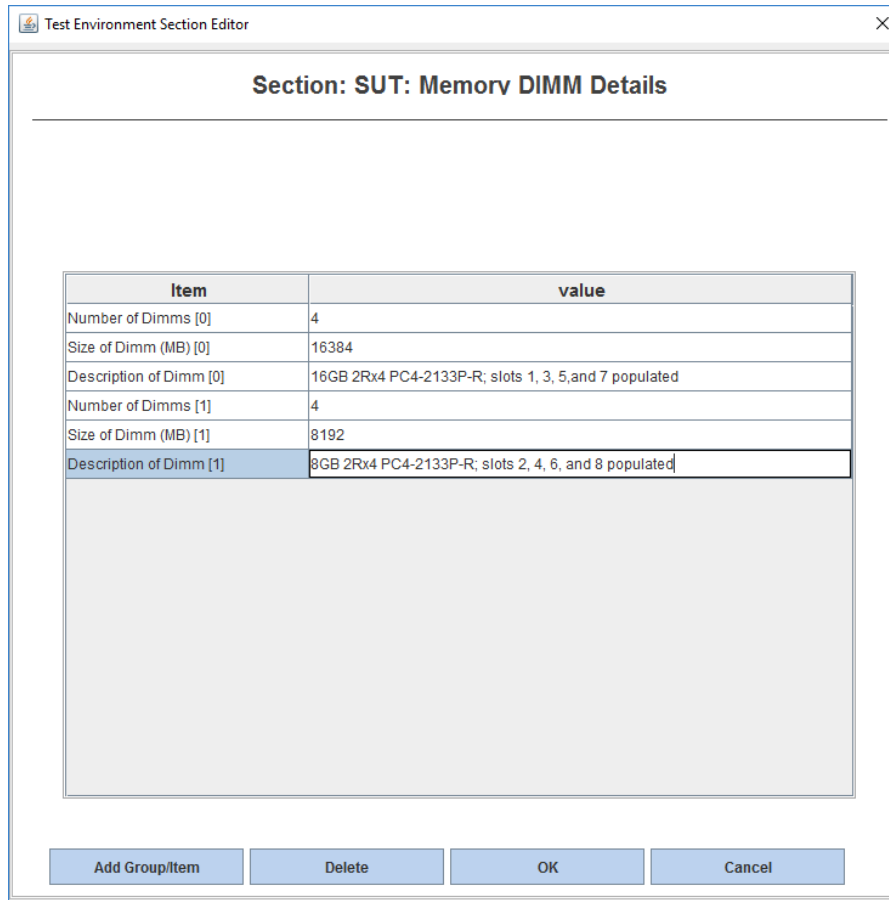

Note that all sections of the test environment information must be complete before continuing further. This is indicated in the right column of the table showing a green color for all sections.

By clicking on the **Save Copy** button the user can save a fully populated template for subsequent re-use. Use the **Load** button to re-load an existing template in place of the current default template.

After editing test environment fields you should preview the System Under Test section of the result report file by clicking on the **Preview Report** button.

Click **Next** to continue.

Note: For the purposes of informal testing, the user may choose not to edit any of the test environment information provided by the default template. Simply click **Next** to continue.

Note: All status fields showing the state **“Complete”** are highlighted green to represent that all information fields have been changed from their default values. It does not necessarily indicate that the information within these fields

is correct and valid for publication. The tester has to verify the correctness of all the information manually and make the required changes.

The default parameters are defined with a leading underscore to clearly mark them as placeholder values that must be edited to produce valid results. The reporter recognizes default placeholders and highlights these fields with a yellow background in the result file.

3.3.5. PTDaemon® Configuration

The **PTDaemon Configuration** panel allows the user to view and edit settings associated with temperature and power instances of PTDaemon. There is a tab for the **Power Analyzer** and for the **Temperature Sensor**. Additional devices can be added with the **Add** button or removed with the **Remove** button; this is a convenient way to retain configuration information in a lab environment where multiple devices are available.

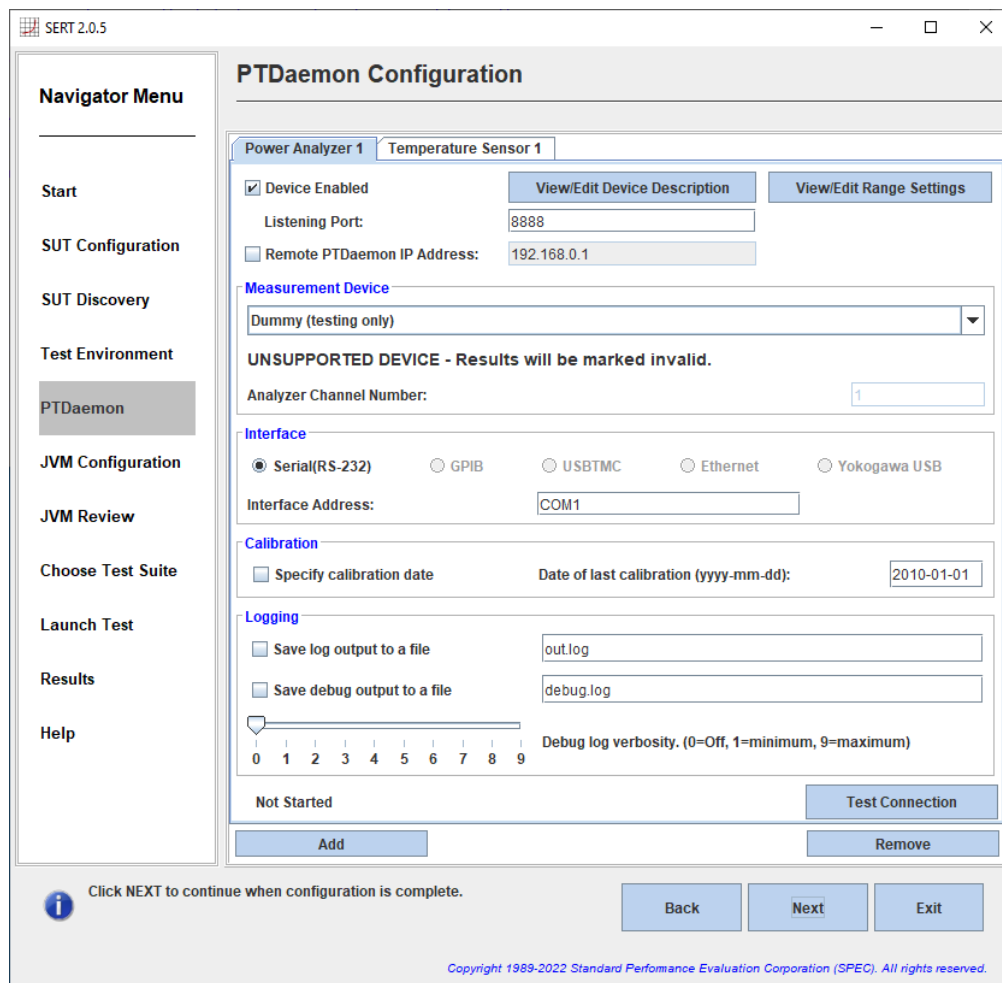

For the **Power Analyzer** tab, there are four sections:

- **Measurement Device:** Choose which power analyzer is being used from the drop down menu. Once a device has been selected, only the options appropriate for that device will be displayed in the remaining sections.
Note: The default Analyzer Channel Number (0) may not be correct for multi-channel analyzers used in single-channel mode. If PTDaemon fails to launch the channel number may need to be changed, e.g. to 1.
- **Interface:** Choose how the power analyzer is connected to the controller, and specify the interface address.
- **Calibration:** Specify the date of last calibration for the power analyzer.

- **Logging:** If needed, save a log and/or debug output file by clicking on the checkbox. This should not normally be used except under guidance from SERT support personnel.

After making your choices, click on **Test Connection** to start the connection between the power analyzer and the controller. Be patient, as this process may take 30 seconds or more.

Note: If the connection cannot be established the following message is displayed “Unable to launch PTDaemon, please check settings and retry.” Click on the **Reset** button and then check “Listening Port:”, “Analyzer Channel Number:”, and “Interface Address:” settings before clicking **Test Connection** again.

Power for the different SERT worklets and load levels may vary significantly. This may result in current readings which fall outside the limits of the given ampere range. This will lead to invalid power readings or high uncertainty values (>1%), in both cases the result will be marked invalid. In order to avoid such conditions, power ranges must be adjusted dynamically during a SERT measurement run. Also, the power analyzer voltage range must be set to match the standard voltage of the test environment. Proper setting of the voltage range is a prerequisite for correct calculation of uncertainties.

Both voltage and current ranges can be specified individually per workload, worklet and load level in the `listeners.xml` file or under **View/Edit Range Settings** in the PTDaemon configuration panel.

Range settings from previous runs will be imported from `listeners.xml` by the SERT UI and only need to be edited after configuration changes. It is strongly recommended though to check the settings for correctness before starting a test run.

The GUI offers a method to partially automate the specification of range values by running a brief test prior to a full SERT run. See Section 5 for instructions on performing a range-setting run.

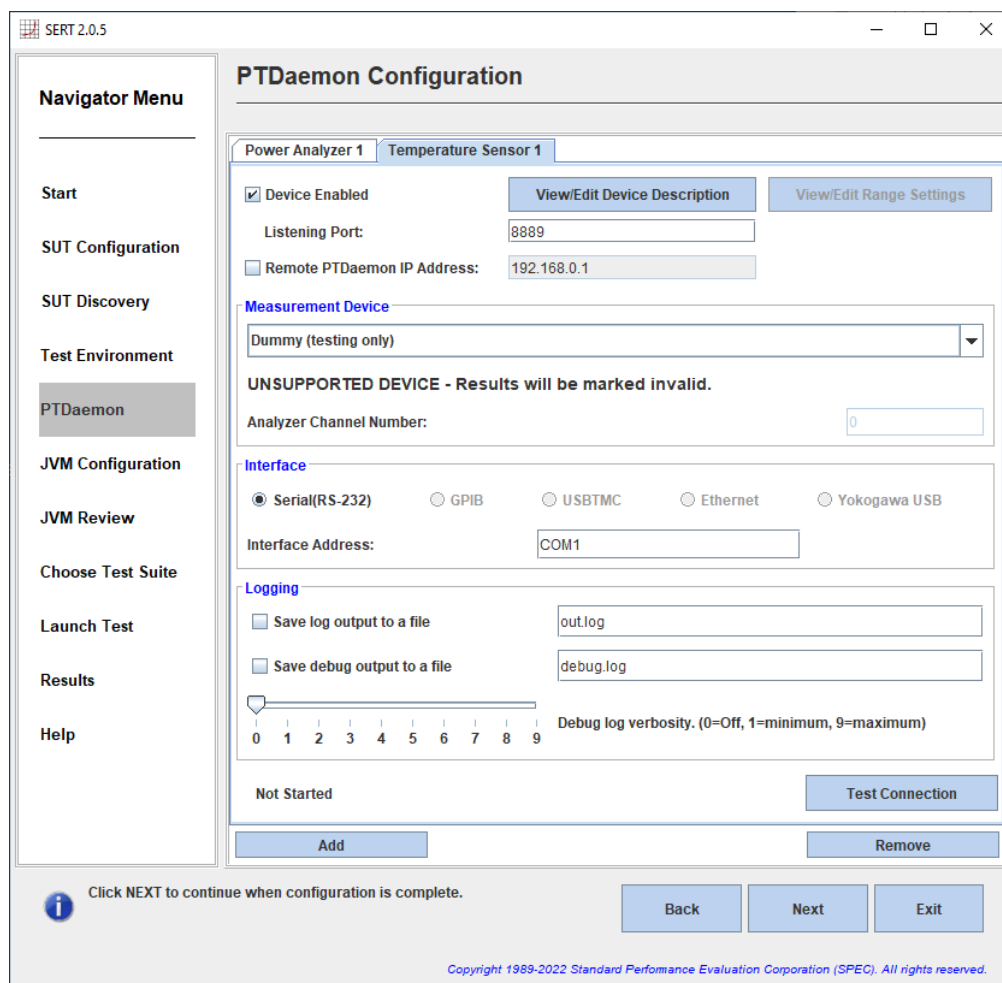

For the **Temperature Sensor** tab, there are three sections:

- **Measurement Device:** Choose which temperature sensor is being used from the drop down menu.
- **Interface:** Choose how the temperature sensor is connected to the controller, and specify the interface address.
- **Logging:** If needed, a log and/or debug output file can be saved by clicking on the checkbox.

After making your choices, click on **Test Connection** to start the connection between the temperature sensor and the controller.

3.3.5.1 View/Edit Device Description

The following figure shows an example of a power analyzer device description. A similar description panel is available for temperature sensor devices. Device descriptions should always be checked for correctness, especially if the test environment description was imported from an existing description file using the Load function of the Test Environment panel (see description above). Imported device information will only be shown here if the PTDaemonPort field in the test environment file does match the PTDaemon Listening Port configured in the Power Analyzer tab of the PTDaemon panel.

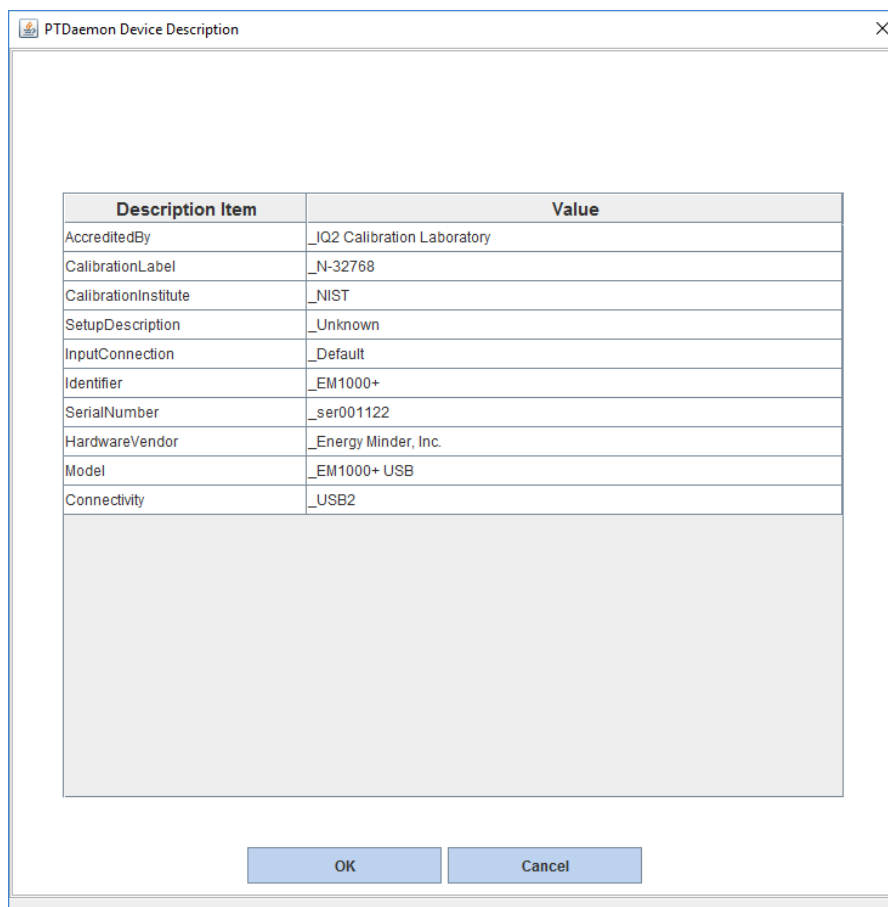

Information shown here is imported from the `test-environment.xml` file. Each field can be edited individually to match the given configuration. Specifically you need to ensure that the power analyzer has been calibrated within one year before running the test. The corresponding CalibrationLabel must be specified in the appropriate field. A field for specification of the calibration date is available in the Power Analyzer tabs of the PTDaemon Configuration panel (see description above).

The device description is copied to the `test-environment.xml` file for use in subsequent SERT runs.

3.3.5.2 View/Edit Range Settings

Voltage and current ranges can be specified in the **PTDaemon Device Range Settings** panel, see picture below.

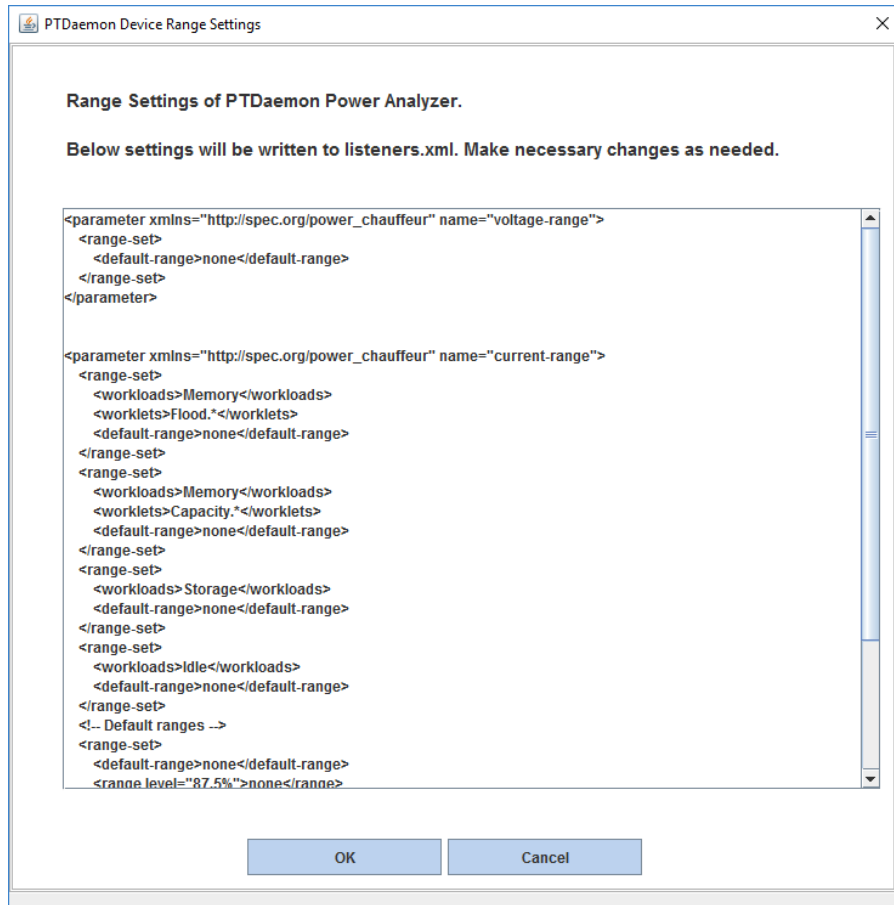

The default ranges (**none**) shown in the example above must be replaced by a suitable current or voltage value. Range definitions for other workloads, worklets and/or intervals can be added here as well.

The new information is copied to the `listeners.xml` file and used for subsequent SERT measurement runs.

The process to find suitable range settings for a given configuration is described in more detail in chapter 5. Power analyzer specific information is given in the [SPECpower-Measurement Setup Guide.pdf](#) document.

3.3.5.3 Additional Power Analyzer and Temperature Sensor Device

Additional device can be included by pressing the Add button.

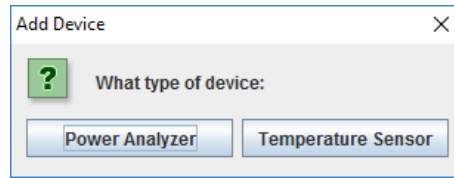

Select the device type and modify that setting to match your device. Please note to change the listening port as well (one port per device).

Example: Power Analyzer added

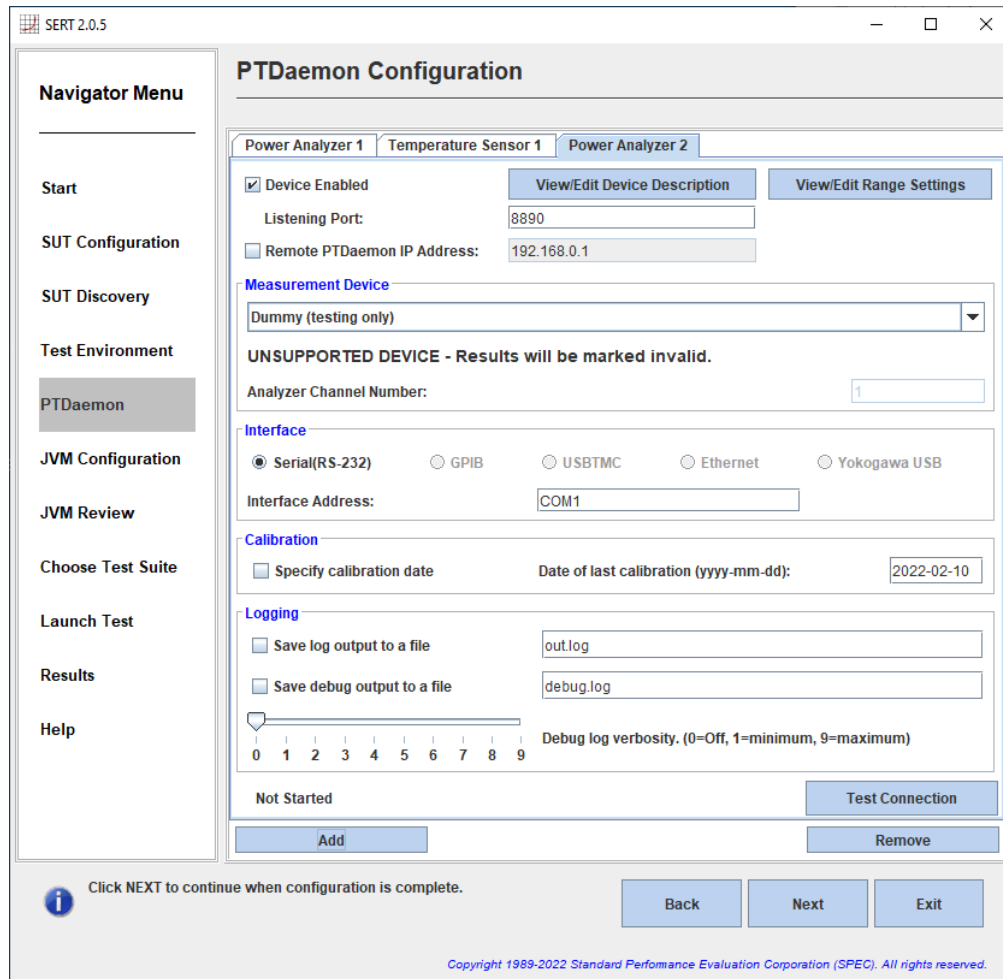

3.3.6. JVM Configuration

The **JVM Configuration** panel allows the user to select the parameters of the tested SUT configuration in order to identify the corresponding Client Configuration ID in the local `client-configurations-2.0.xml` file.

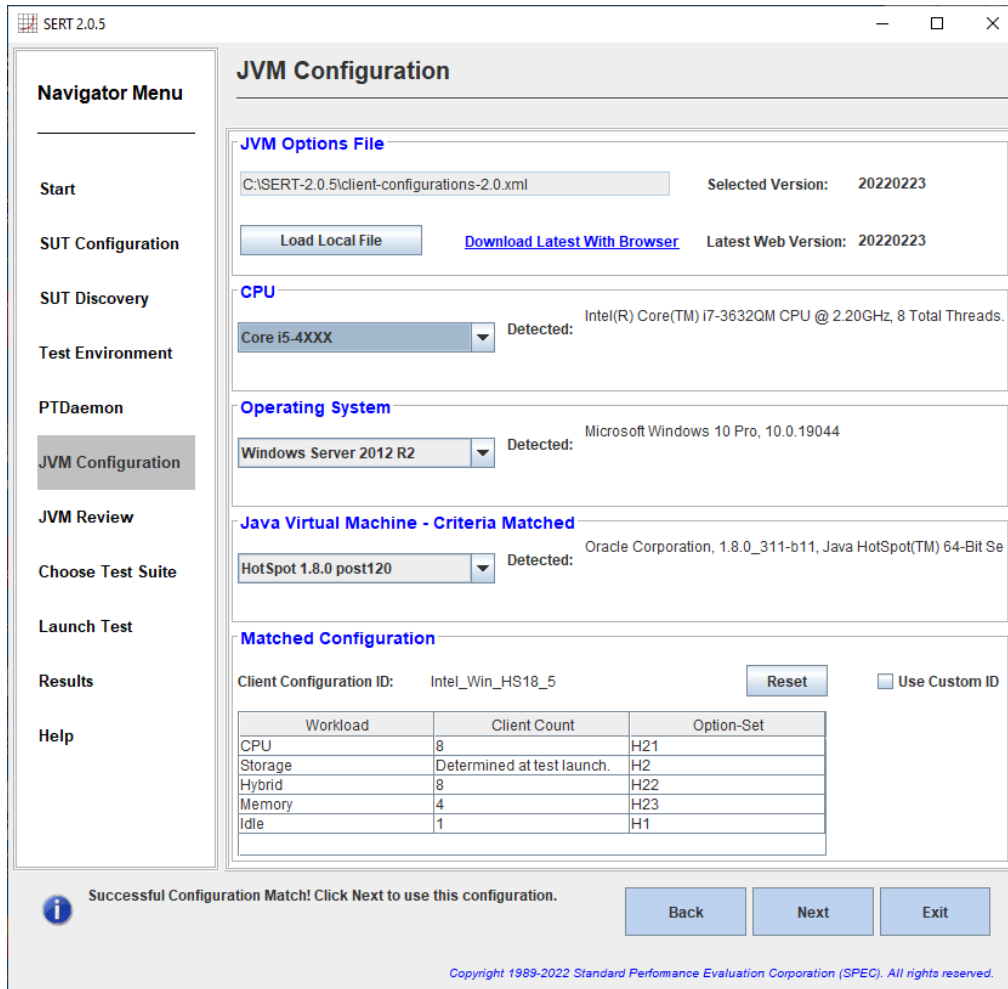

Note: Before selecting configuration parameters make sure that the local copy of the `client-configurations-2.0.xml` file matches the latest version of this file which is available on SPEC's web site at <https://www.spec.org/sert2/client-configurations-2.0.xml>. The GUI will check this for you automatically; it is reported as the "Latest Web Version". If necessary, you can set a web proxy in the GUI startup scripts (`run-sertui.bat` or `run-sertui.sh`). If the version strings don't match, you can download the latest version by clicking on the **Download Latest With Browser** hyperlink. After you have downloaded the latest version, click on the **Load Local File** button for opening this version in SERT UI (see picture below). If the controller doesn't have internet access you can download the `client-configurations-2.0.xml` from the URL above from another system, transfer it to a folder on the controller system, and then press "Load Local File" to load the new version.

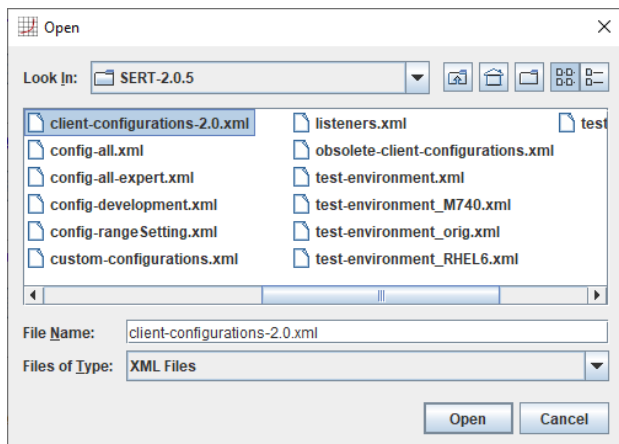

The code will automatically pick the correct JVM options for each workload from the specified set and start the client JVMs with these options. The option sets for all supported platform / OS / JVM combinations have been defined by the platform manufacturer and must be used for compliant SERT runs. If the CPU, Operating System, or Java Virtual Machine are not detected properly, the drop-down boxes can be used to select the correct values; however, selecting the incorrect values would result in a non-compliant run. If the values are all set correctly but no matching configuration is found, this platform is not currently supported. Please check http://www.spec.org/sert2/SERT-JVM_Options-2.0.html for a list of supported platforms. You may be able to use a different JVM or Operating System instead. If the processor is not on the supported list, you may wish to contact your processor vendor to encourage them to complete the platform acceptance process so it will be supported in the SERT suite.

Please note that SERT 2.0.5 requires Java 8 or newer. For Java 7 measurements, SERT 2.0.3 with the latest 2.0.3 client configurations (<https://www.spec.org/sert2/client-configurations-2.0.3.xml>) must be used. The supported platforms can be reviewed via https://www.spec.org/sert2/SERT-JVM_Options-2.0.3.html.

3.3.7. JVM Review

The **JVM Configuration Review** panel allows the user to review the JVM options and the number of client JVMs used for each workload during the measurement. This is for information only, press Next to proceed.

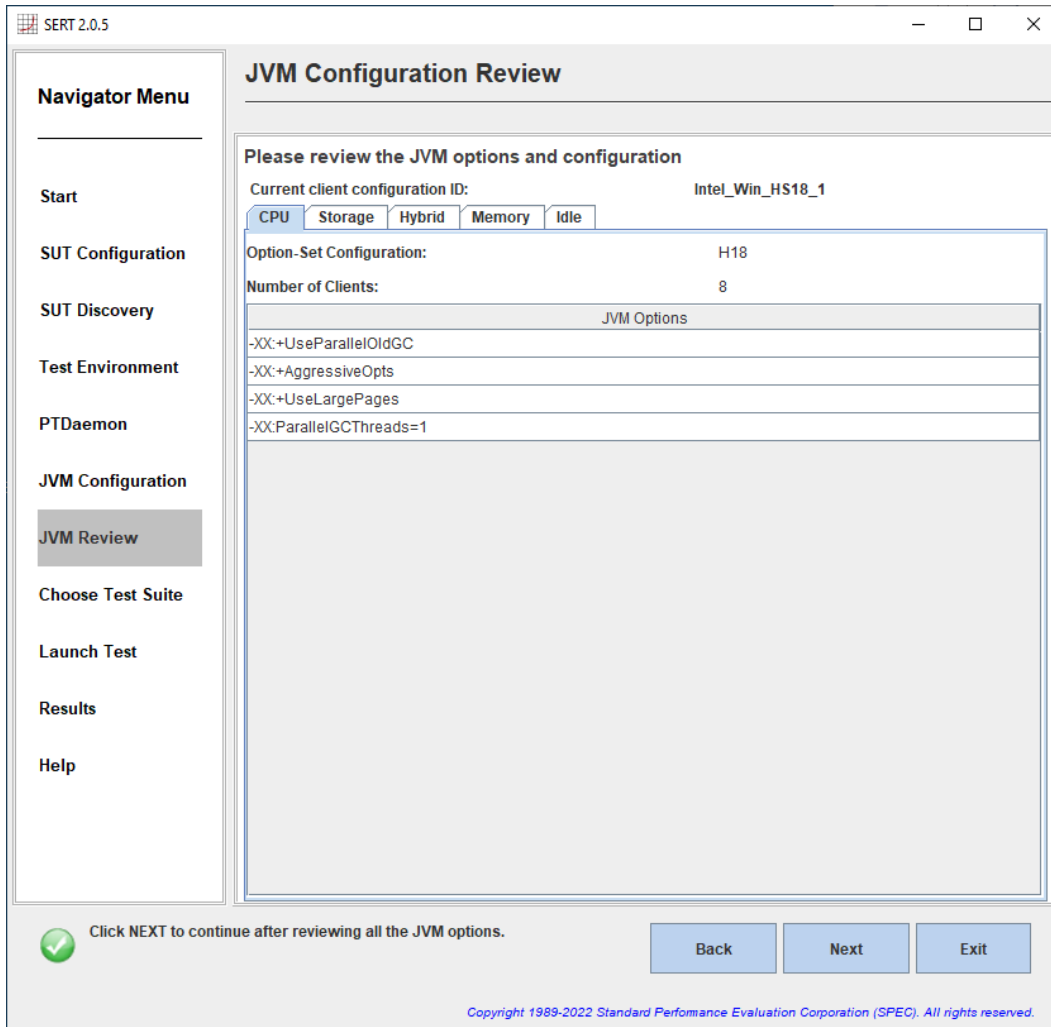

3.3.8. Choose Test Suite

The **Choose Test Suite** panel allows the user to choose the test to run, to configure key launch variables, and to view configuration information about the test. For a compliant run the “Full Test Suite (config-all.xml)” configuration including all worklets must be selected.

For selection of proper power analyzer ranges the user can choose the “Range Discovery (config-rangeSetting.xml)” option from the “Choose Test Configuration:” drop down menu. This option is described in more detail in section 5.1 (Automating Range Settings using the GUI).

Note: Range discovery test configurations will cause the results to be marked **invalid** and **must not** be used for official SERT results to be sent to government agencies for their respective efficiency programs.

Note: For the purposes of informal testing, the user may choose to select individual worklets. For a valid run, all worklets must be enabled.

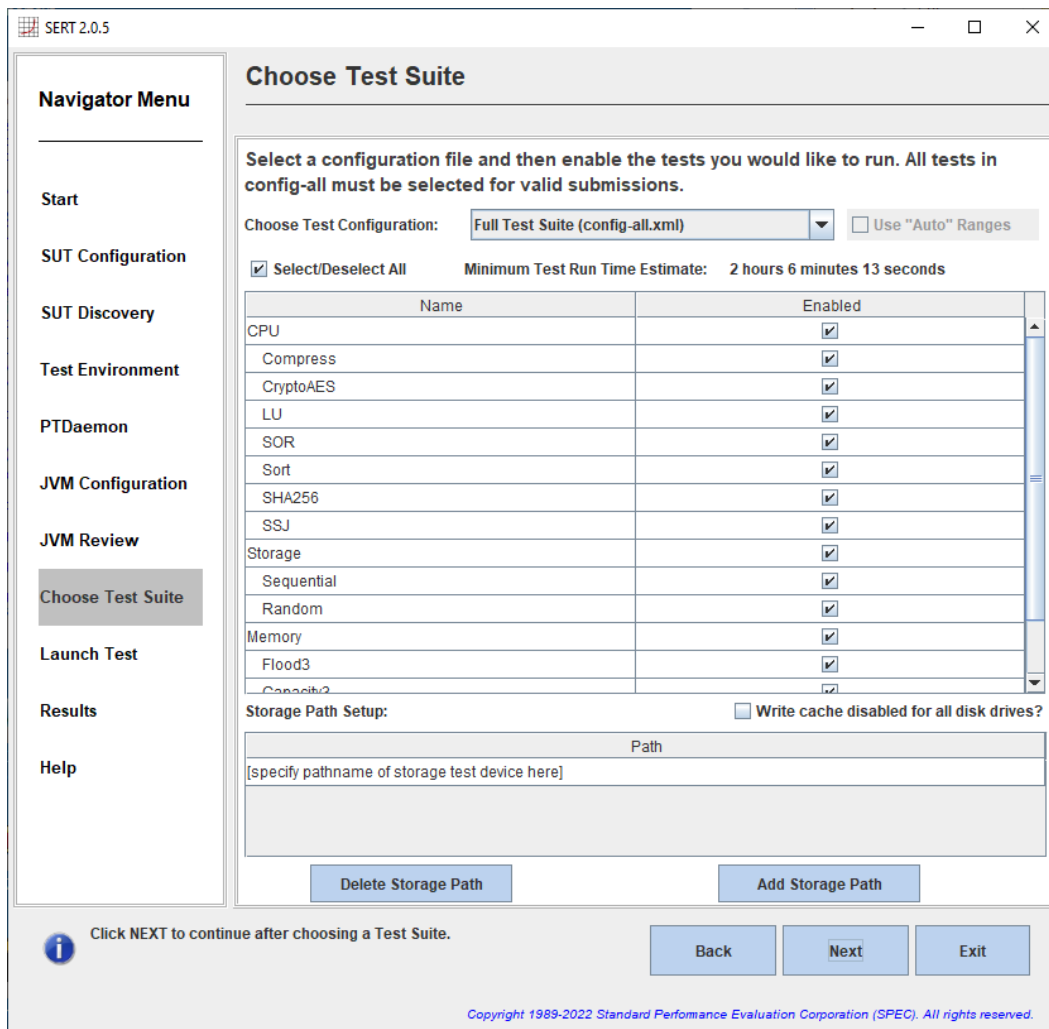

In the Storage Path Setup section, specify the paths of all configured storage devices under test. Separate pathname fields are required for each storage device. More devices can be added using the **Add Storage Path** button. Each time the **Add Storage Path** button is clicked, a new pathname field is created at the bottom of the existing list of pathnames as shown in the following figure. Clicking on the **Delete Storage Path** button will delete the currently selected pathname field. You must enter a pathname referencing a filesystem on a storage device here. The system

partition, e.g. "C:" under Windows must not be specified here. Instead only the pathname for the additional test partition must be given here e.g. "D:\" (Windows) or "/home/user/disk1" (LINUX/UNIX).

Note: According to the SERT run rules, write caches must be disabled for all storage devices. You must select the **Write cache disabled** check box to confirm the storage write caches is disabled. If this check box isn't selected a warning will be displayed later when the test is launched.

Click **Next** to continue after making the selections.

Note: If you start the SERT suite and the specified storage path name does not exist, the following message will appear:

```
Storage verification failed on SUT <SUTNAME>. Storage path <PATHNAME> does not exist. Would you like to continue launch of test suite?
```

Note: If there is insufficient free space on the specified storage device(s), the following message will appear:

```
Storage verification failed on SUT <SUTNAME>, not enough free space available. Would you like to continue launch of test suite?
```

If either error appears, it is highly recommended that the test be terminated immediately and the reported error be corrected before restarting the SERT suite. If the test is not terminated immediately, it will eventually fail.

3.3.9. Launch Test

The **Launch Test** panel is used to initiate a SERT measurement, and to monitor its progress. Click **Launch** to begin the test. **Cancel** is available and may be used as necessary. The SERT Suite will finish the current measurement interval before exiting, so it may take a few minutes for the run to stop.

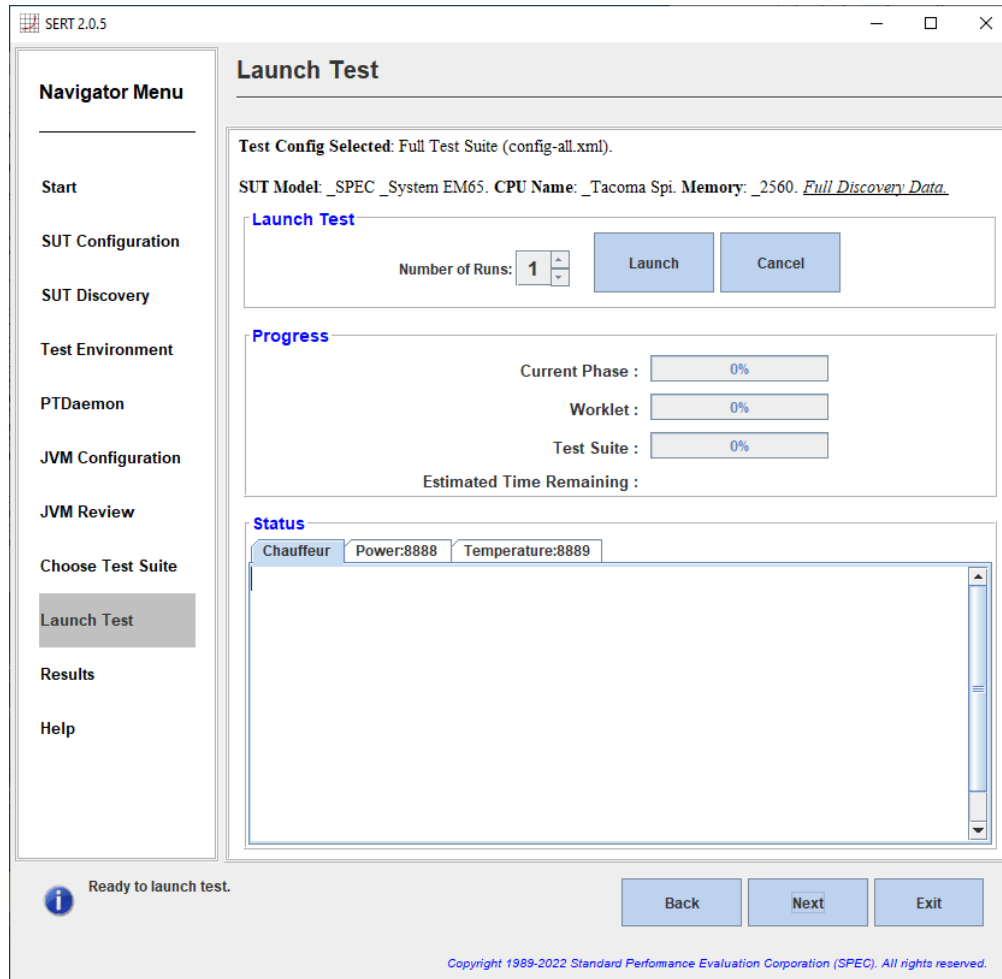

After a few seconds, the SERT Suite will run a series of pre-run validation checks -- if any potential issues are detected, warning messages will be displayed and a dialog box will let you choose whether to ignore the warnings and proceed with the run, or to stop the run so you can address the issues.

Here are two sample dialog boxes:

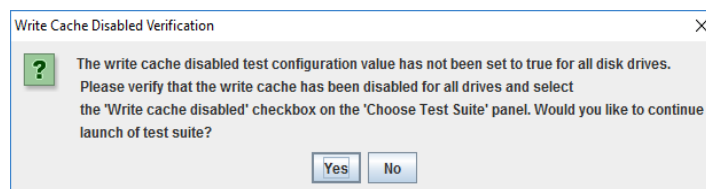
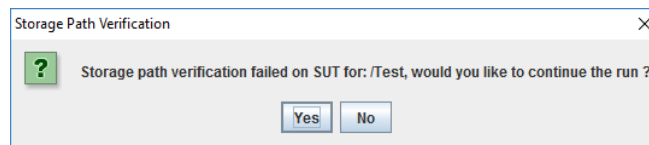

Status messages and Progress information will be displayed and the test will proceed as intended. Estimated Time Remaining is approximate and might be significantly longer for high-end configurations, especially multi-node configurations.

Users should wait until the progress bars start to increase beyond 0%; at this point the run should complete without further user interaction. In some cases, the Progress Bar and Estimated Time Remaining may appear to not show any progress, even though the SERT measurement is functioning correctly.

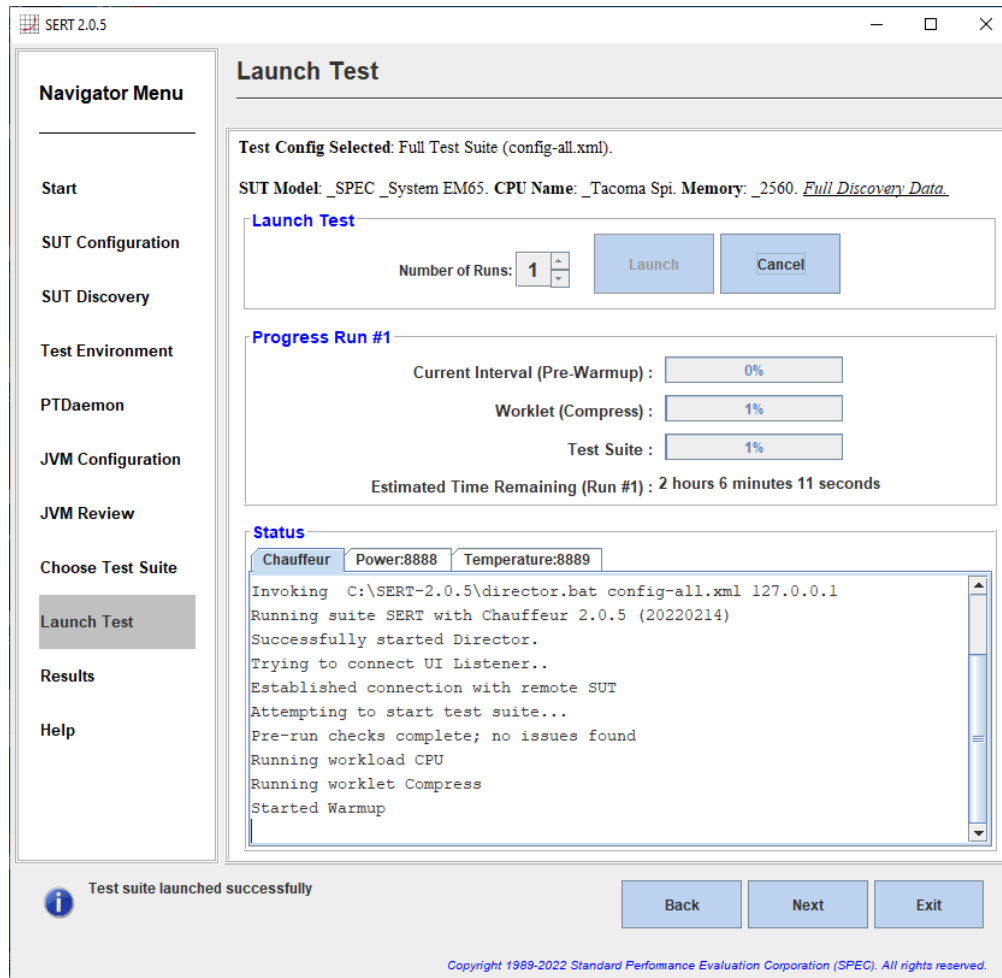

When the test completes, click **Next** to continue.

If a “Failure in processing results, please check the logs.” occurs, please verify that enough heap size for the director was set and check the log files, see section 3.1.3.

3.3.10. Results

The **Results** panel allows the user to view and archive the results, sometimes called Full Disclosure Report (FDR), from the test pass that has just completed.

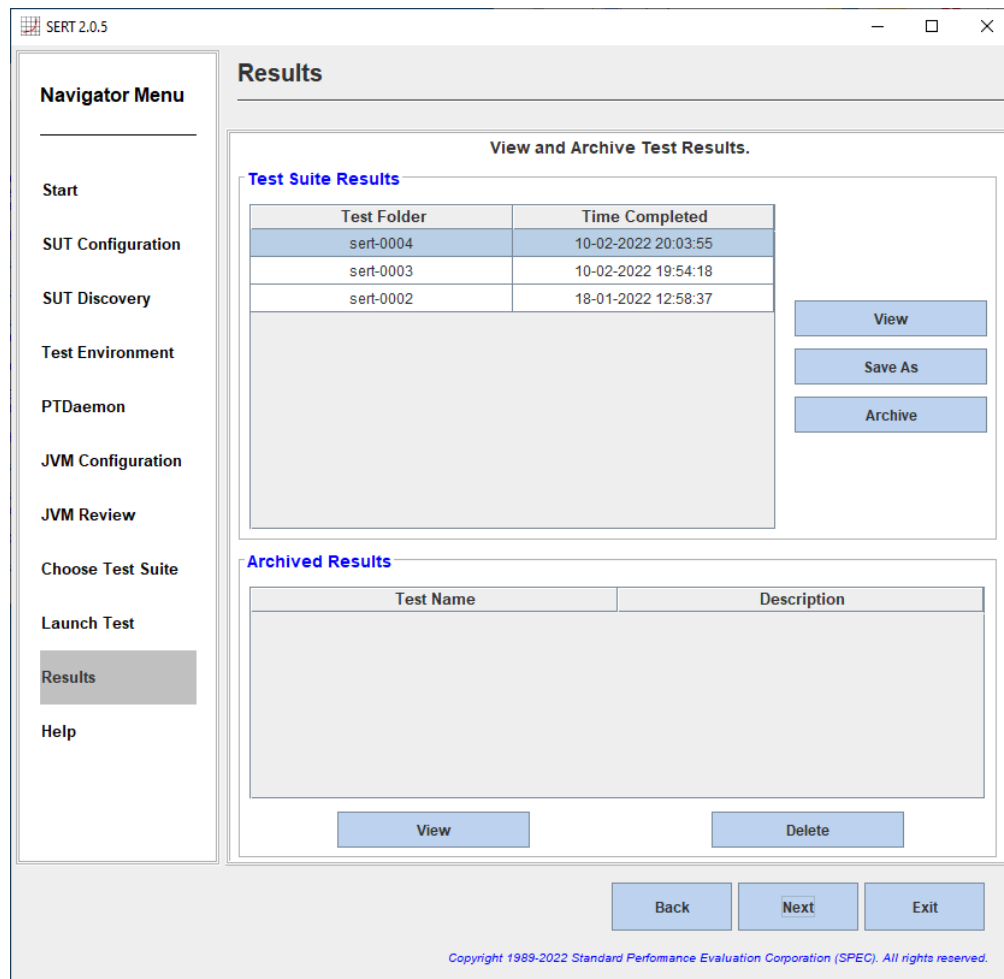

Click **View** to load the results in the default Web browser. Please notice any Warning or Invalid messages on the top of the report. If power and temperature data is shown as zero or invalid after a test run please verify your connections and power cycle the Power Analyzer, as the SERT Suite cannot currently repair this misconfiguration.

Click **Save As** to save the results folder to a location of choice.

Click **Archive** to name, annotate, and save the results folder to the default "Archive" directory and enter them into the table provided.

Once placed in the archive, the results can be browsed at any time by clicking on **View**.

The test is now complete. Exit the GUI by clicking on **Exit**.

3.3.11. Help

The **Help** panel provides release information and links to various documents made available to the user.

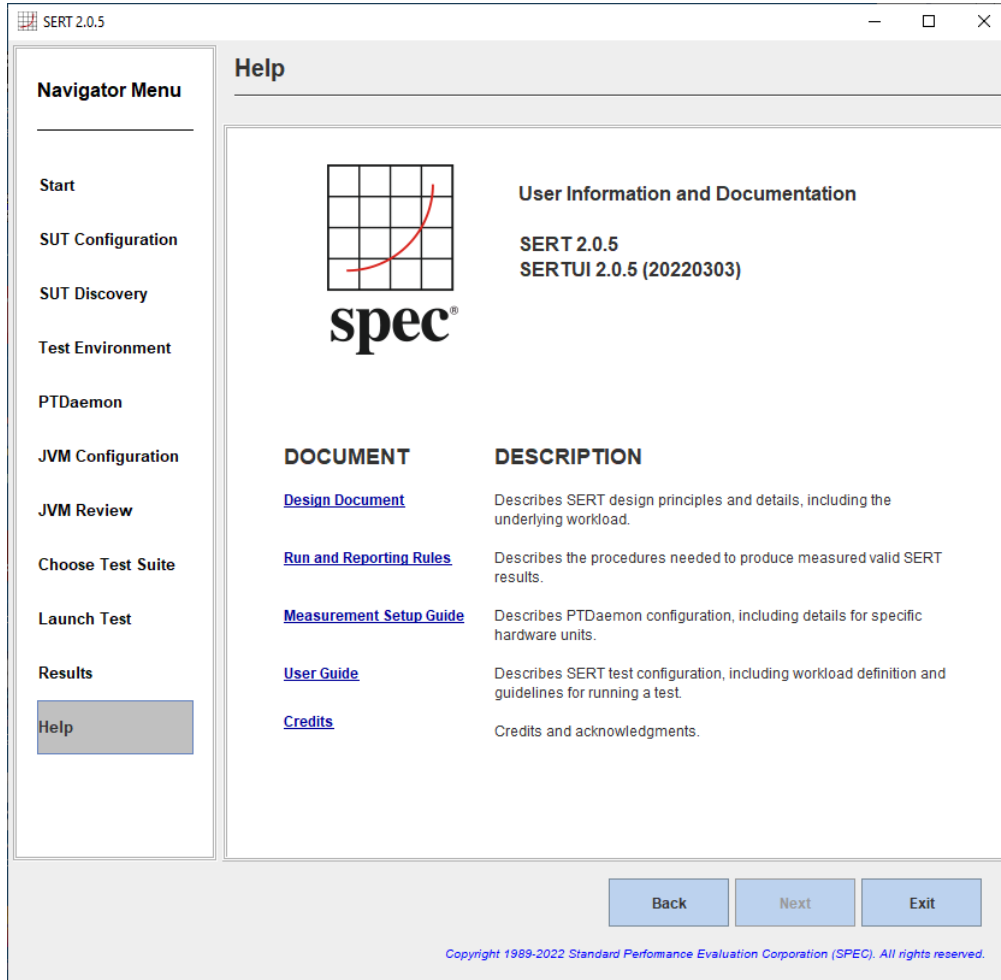

4. Platform Specific Settings

4.1. Microsoft Windows Server 2012, 2016, 2019

4.1.1. Lock Pages in Memory

For a 64-bit environment, it is necessary to enable the “Lock Pages in Memory” user rights policy, which may be done as follows:

- On the **Start** menu, click **Run**. In the **Open** box (or from a CMD or PowerShell window), type **gpedit.msc**. The **Group Policy** dialog box opens. The user account running this tool needs to be a system administrator.
- On the **Group Policy** console, expand **Computer Configuration**, and then expand **Windows Settings**.
- Expand **Security Settings**, and then expand **Local Policies**.
- Select the **User Rights Assignment** folder. The policies will be displayed in the right hand details pane.
- In the pane, double-click **Lock pages in memory**.
- In the **Local Security Policy Setting** dialog box, click **Add**.
- In the **Select Users or Groups** dialog box, add the user account that will be used to run the **SERT Suite** (typically “Administrator”).
- **Restart the machine** for these changes to take effect.

4.1.2. Disabling the storage write cache

For systems with Windows Server installed, each storage device will usually appear in the Device Manager. To disable write caching, select the desired storage device in the Device Manager, then either double click, or right click and select **Properties**. Select the **Policies** tab to display the interface that allows the disabling of write caching:

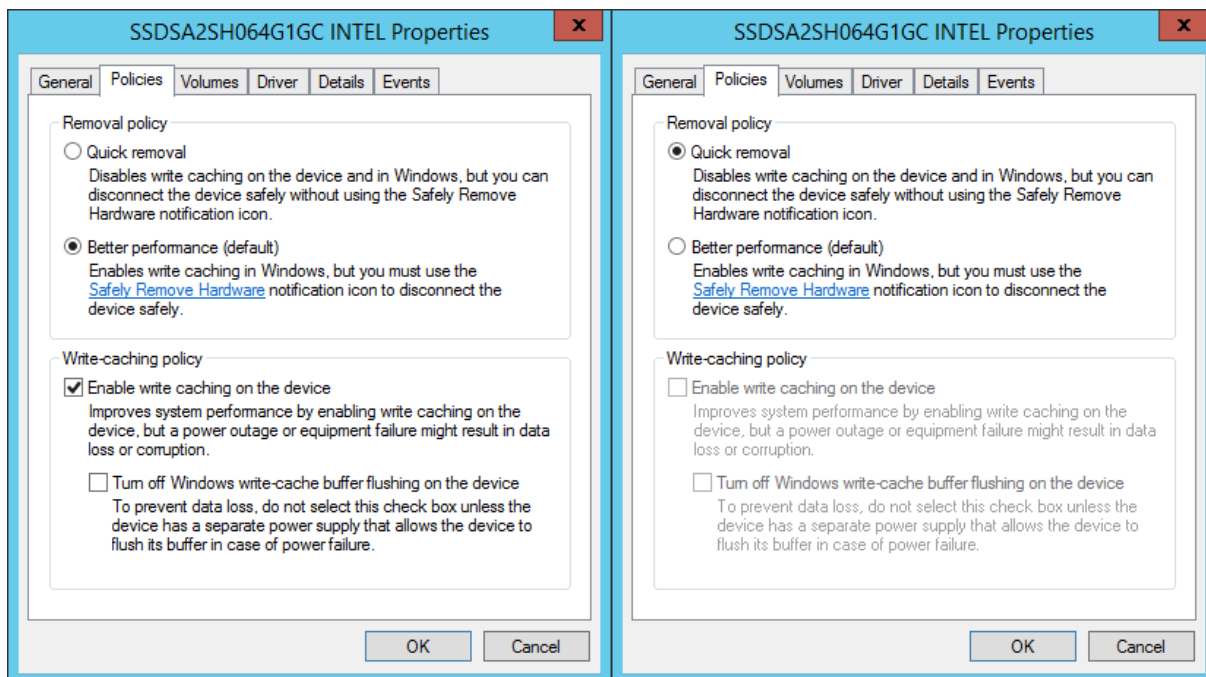

This (left) shows write caching enabled, click on the checkbox **Enable write caching on the device** to disable it; e.g. the tick will disappear. Also click on the **Quick removal** button to disable write caching in Windows.

4.1.3. Disabling the Windows firewall

The firewall may be disabled by Open the Windows Control Panel and then click on the Windows Firewall applet.

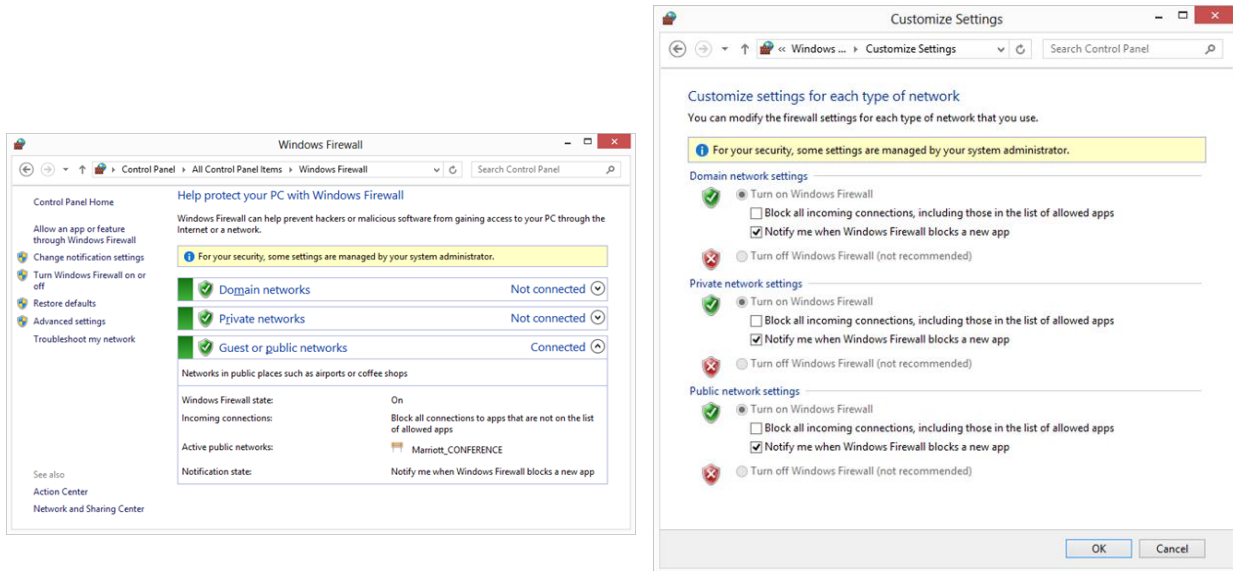

Select Turn Windows Firewall on or off from the left hand side of the Firewall applet, then Click on the Turn off Windows Firewall for the relevant network(s); e.g. Domain, Private or Public, then click on OK.

Note that naming for this setting may vary across different Windows versions (ex. Windows Defender/Firewall) and the view in Control Panel may need to be changed to large/small icons.

4.1.4. Open firewall port for the SERT Suite

Some test environments may not allow disabling the firewall completely. In order to run the SERT Suite under these conditions a specific port must be enabled for SERT communication. Here is a description how to open a firewall port under Windows Server 2012.

Open the Windows Control Panel and then click on the Windows Firewall applet. Select Advanced settings on the left hand side.

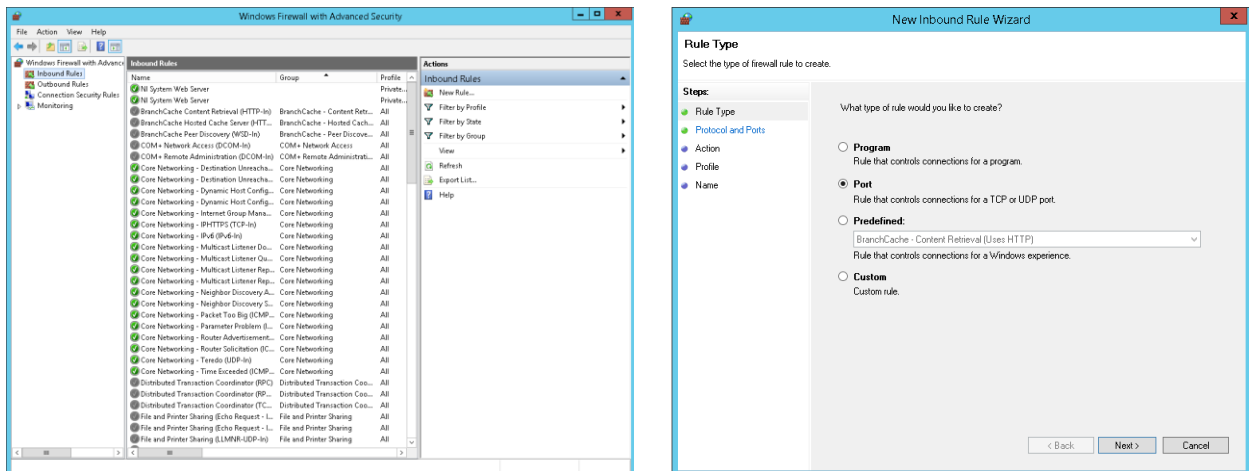

Select "Inbound Rules" and click "New Rule" under the Actions Menu, then select the "Port" option and click Next.

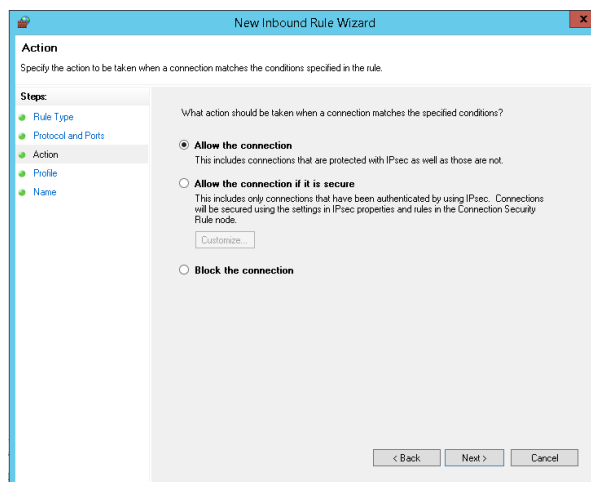
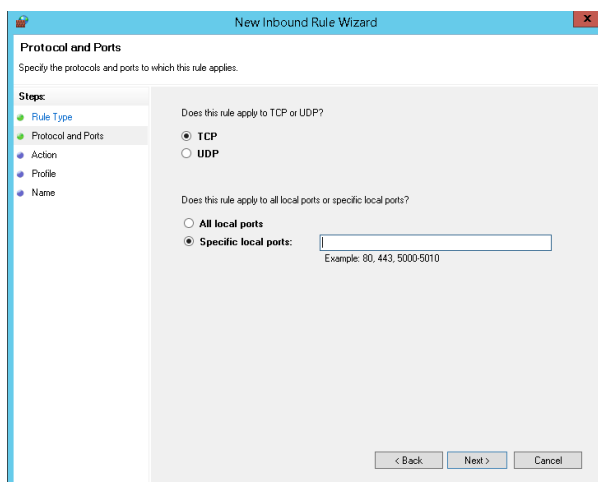

Enter port number (9999) in the “Specific local ports:” box, then click Next, than keep the “Allow the connection” option selected and click Next.

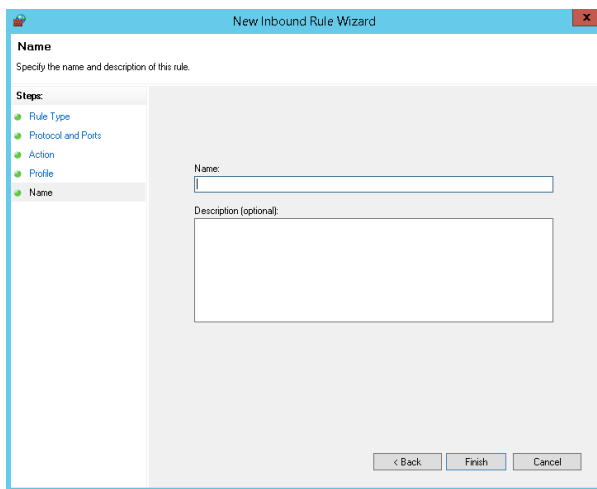
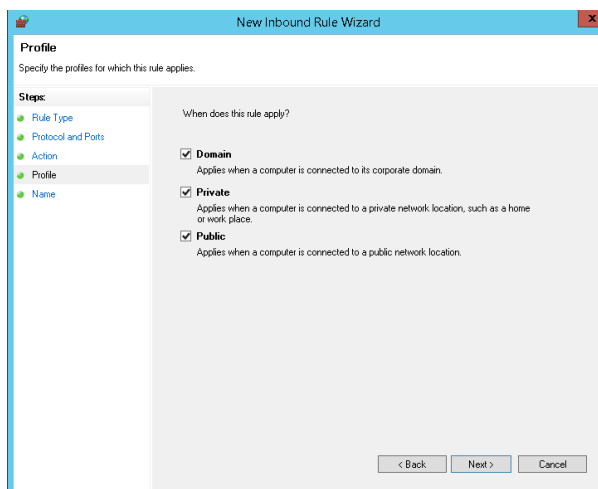

Select any required networks and click Next, than Assign a name to the rule and click Finish.

4.1.5. Windows 2008 R2 Systems with > 64 logical processors

For systems running more than 64 logical processors on Windows 2008 R2 an issue where logical processors are unevenly allocated to K-Groups can occur. This can cause performance issues and high run to run variation, please contact your OS vendor for a resolution.

4.1.6. Windows Server Hyper-V

Virtualized environments are not tested nor supported. Nonetheless when Hyper-V is enabled on Windows Server, the host partition is limited to 64 processors, see <https://support.microsoft.com/en-us/kb/2812283>. For Windows Server 2016 and 2019, see <https://docs.microsoft.com/en-us/windows-server/virtualization/hyper-v/plan/plan-hyper-v-scalability-in-windows-server>.

4.1.7. Windows Server and OpenJDK 11

In some OpenJDK 11 distributions, the necessary *msvcr100.dll* runtime dll is missing, causing the following error (“Can’t find dependent libraries”) during a storage worklet run:

```
java.lang.UnsatisfiedLinkError: C:\Users\Administrator\AppData\Local\Temp\2\jna-146731693\jna12904646497438529322.dll
```

This can be addressed by retrieving and installing the missing dll package from here:

<https://www.microsoft.com/en-us/download/details.aspx?id=13523>

4.2. Linux

4.2.1. Prerequisite Software

In addition to the base operating system and Java Virtual Machine, the SERT Suite requires the numactl command for SUTs that have more than one memory controller and the ethtool command. If numactl and ethtool are not installed by default on your Linux distribution, use the appropriate commands to install the necessary package(s).

For example:

```
yum install numactl (RHEL)

sudo apt-get install numactl (Ubuntu)

sudo apt-get install ethtool (Ubuntu)

zypper install numactl (openSUSE)
```

4.2.2. Enabling Transparent Huge Pages (THP)

Transparent Huge Pages (THP) must be enabled when running the SERT Suite in a 64-bit Linux environment where THP is supported. Earlier versions of RHEL and SLES do not enable this feature by default, although other untested distributions may do so. To determine whether Transparent Large Pages are enabled for the system, run the following command:

```
cat /sys/kernel/mm/transparent_hugepage/enabled
```

Note: In some older version of RHEL the following command is necessary:

```
cat /sys/kernel/mm/redhat_transparent_hugepage/enabled
```

The user should see the following output: "[always] never", with the always in brackets indicating that Transparent Large Pages are enabled by default on the system. If this file exists, but the output shows [never], [mmap], or [madvise], please run the following command at startup to enable Transparent Large Pages:

```
echo always > /sys/kernel/mm/transparent_hugepage/enabled
```

Note: In some older version of RHEL the following command is necessary:

```
echo always > /sys/kernel/mm/redhat_transparent_hugepage/enabled
```

4.2.3. Disabling the storage write cache on Linux

For instructions on how to disable the different write caches, please read the manuals provided by the manufacturers of the system, controller and storage devices. Different versions of Linux provide different mechanisms for disabling disk caches, so it may be necessary to contact the manufacturer of your storage device(s) if neither the manufacturer's manuals nor the operating system documentation explain how to do this.

For an example using openSUSE, the following command reveals that write caching is on for drive sda:

```
linux-openSUSE:~ # hdparm -W /dev/sda

/dev/sda: write-caching = 1 (on)
```

The result will be "0 (off)" if write caching is already off for sda. To turn off write caching for that drive, enter the following command:

```
hdparm -W0 /dev/sda
```

To turn write caching back on:

```
hdparm -W1 /dev/sda
```

4.2.4. Disabling the firewall

Different Linux distributions may have different default firewall configurations and use different commands to disable the firewall.

In RHEL 6.x and SLES, issue the following command as root:

```
chkconfig iptables off
```

For RHEL 7 and other Linux distributions that use systemctl, issue this command as root:

```
systemctl disable firewalld
```

For Ubuntu 14.04 LTS, use:

```
sudo ufw disable
```

For openSUSE Leap 41.x, use:

```
/sbin/rcSuSEfirewall2 stop
```

A reboot may be required after running these commands in order for them to take effect.

4.2.5. Open firewall port for the SERT Suite

Some test environments may not allow disabling the firewall completely. In order to run the SERT Suite under these conditions a specific port must be enabled for SERT communication. Here is a description how to open a firewall port under Linux. For RHEL 7 and other Linux distributions that use systemctl, run the following commands as root:

```
firewall-cmd --zone=public --add-port=9999/tcp --permanent  
firewall-cmd --reload
```

4.2.6. Linux on IBM Power Systems

Transparent Huge Pages are not supported on IBM Power systems running RHEL 6.x or SLES 11.x. For these distributions, large pages must be configured manually on systems with more than 32 GB of memory.

Sign on as the root user

Download the newest libhugetlbfs library from the project home, at the following URL:

<http://sourceforge.net/projects/libhugetlbfs/files/>

Execute the command:

```
cat /proc/meminfo | grep MemTotal
```

This returns the total memory available to the operating system in Kilobytes [Value].

Compute the target large pages as follows:

```
targetLP = Truncate(Value/18204)
```

(Note: 18204 is a factor designed to allocate approximately 90% of available memory for large pages).

Execute the following command to set the number of large pages:

```
echo [targetLP] > /proc/sys/vm/nr_hugepages
```

Create the necessary pseudo-filesystem by executing the following commands

```
mkdir /libhugetlbfs  
groupadd libhuge  
chgrp libhuge /libhugetlbfs  
chmod 770 /libhugetlbfs  
usermod root -G libhuge (this assumes "root" is the SERT user on the system)  
mount -t hugetlbfs hugetlbfs /libhugetlbfs
```

Edit /etc/fstab and add the following line

```
hugetlbfs /libhugetlbfs hugetlbfs mode=0770,gid=1000 0 0
```

Execute the following command to mount the huge table space:

```
hugeadm --create-global-mounts
```

4.3. IBM AIX

It is necessary to setup large pages correctly.

Sign on as the root user.

Execute the command:

```
bootinfo -r
```

This returns the total memory available to the operating system in kilobytes [Value].

Compute the target large pages as follows:

```
targetLP = Truncate(Value/18780)
```

(Note: 18780 is a factor designed to allocate approximately 87.25% of available memory for large pages).

Execute the following commands:

```
vmo -r -o lgpg_regions=[targetLP] -o lgpg_size=16777216 -o v_pinshm=1
```

```
bosboot -aD
```

```
shutdown -rF
```

This will cause the system to be rebooted with the large pages set up correctly for the SERT Suite.

4.3.1. Disabling the AIX firewall

AIX does not have a firewall enabled by default. For information on configuring or disabling IPsec, see the AIX Knowledge Center:

https://www-01.ibm.com/support/knowledgecenter/ssw_aix_71/com.ibm.aix.security/ipsec.htm

5. Power Analyzer Range Settings

Most power analyzers can be set to multiple current ranges. In order to achieve accurate results, the range settings on the device must be set appropriately for the load being measured. Most devices support an auto-ranging mode which will adjust the device automatically as the load changes; however, use of this mode is not allowed for measurement because it takes time for the range to adjust (during which the measured data may not be accurate), and because PTDaemon cannot determine the accuracy of the data while the device is in auto-ranging mode.

The SERT Suite allows you to configure separate ranges for each power analyzer and can adjust the ranges as needed for each measurement interval. These settings appear in the `listeners.xml` file. Each `PowerAnalyzerListener` includes `"voltage-range"` and `"current-range"` parameters. The default configuration includes multiple current range settings for different load levels, but all are set to the same value: `"none"`. This indicates that no change will be made to the settings on the device during a test run.

The range settings may need to be adjusted when making changes to the system under test, the worklets being tested, or changes to the configuration of the operating system. The validation performed at the end of the run will determine if power measurement accuracy thresholds are not being met. If your result includes warnings regarding the power analyzer uncertainty, adjusting the current ranges may resolve the issue.

5.1. Automating Range Settings using the GUI

The **Choose Test Suite** panel gives you the option to select a "Range Discovery" run rather than the standard SERT full run. By selecting this option, the tool will run an abbreviated subset of the SERT worklets which should be sufficient to create range settings that will provide valid measurements in a majority of cases.

The steps to complete such a run are as follows:

1. Once at the "Choose Test Suite" panel, select the "Range Discovery" choice from the dropdown menu.
2. For most power analyzers, it is safe to check the "Use Auto Ranges" box and let the analyzer select the range choices for the run.
3. Complete the remaining settings on this page as documented previously in the User Guide.
4. Proceed to the launch page and launch the run.
5. When the run completes, you will see a message in the lower portion of the panel stating that "range settings have been updated"
6. Return to the PTDaemon configuration panel, stop the PTDaemon instance, and then review the range settings.
7. Return to the "Choose Test Suite" panel, select "Full Test Suite", and continue on to make a full run.

Some power analyzers may be unable to select appropriate ranges automatically, and the range setting run will result in invalid values for ranges. In such a case, you may need to edit range settings from the PTDaemon panel, setting all range values to "none", and then manually set the analyzer to a range that will measure the system at its highest load and rerun the Range Discovery test with "Use Auto Ranges" disabled.

The Range Discovery run should give working settings in most cases, but it is impossible to cover all system types and analyzer types. If range values generated by the run do not give valid measurement results for a full run, you may need to use the manual processes described below.

5.2. Manual Range Settings – Optional

To configure the ranges manually, replace each of the `<voltage-range>` and `<current-range>` entries in the `listeners.xml` file with a value appropriate for your system under test. The range setting should generally be slightly higher than the maximum expected reading during that interval. Each model of power analyzer will support a specific set of ranges; however, the configuration can use any value, and PTDaemon Interface will round the range settings up to the next supported range.

6. The SERT Suite Command Line Usage

6.1. The SERT Suite Configuration and Start Procedure

This section provides details to enable a successful test with a simple server configuration as an alternative to running the GUI. It is recommended to read this section as well as the SERT Design Guide to understand more of the details behind the SERT Suite, and how to configure and run it. Please note that in the following instructions there are typically two script file options: `*.bat` for the Windows OS and `*.sh` for UNIX and Linux OSes.

Configure the analyzer. Edit the power analyzer (`runpower.bat` or `runpower.sh`) and temperature sensor (`runtemp.bat` or `runtemp.sh`) script files. Ensure the proper communication ports and network ports are used. (The batch and script files are present in the `SERT\PTDaemon` directory).

- For each additional power analyzer: Create a copy of `runpower.bat` or `runpower.sh` and ensure that the proper communication ports and network ports are set.
- In order to analyze problems reported by PTDaemon it may be helpful to generate log files. To do this, edit the script files to set the `LOGFILE` and optionally the `EXTLOG` variables. `LOGFILE` should be set to the name of the file which will hold the log output. Log files may not be shared, so the names given to each must be unique. If extended logging of range settings, warnings, errors, and other important events is desired, set the `EXTLOG` variable to "TRUE".

Start all power analyzer PTDaemon(s) (`runpower.bat/runpower.sh`) and temperature sensor PTDaemon (`runtemp.bat/runtemp.sh`).

Edit the `test-environment.xml` file (in the SERT directory), describing the hardware and software details of the test setup. The default values in this file need to be changed to match the real test environment.

- For each additional power analyzer: Add the following section to the `test-environment.xml` in the `<MeasurementDevices>` section and change the default values to match the real test environment.

```
<PowerAnalyzer>
  <Identifier>_EM1000+</Identifier>
  <PTDaemonHostname>localhost</PTDaemonHostname>
  <PTDaemonPort>8888</PTDaemonPort>
  <HardwareVendor>_Energy Minder, Inc.</HardwareVendor>
  <Model>_EM1000+ USB</Model>
  <SerialNumber>_ser001122</SerialNumber>
  <Connectivity>_USB2</Connectivity>
  <InputConnection>_Default</InputConnection>
  <CalibrationInstitute>_NIST</CalibrationInstitute>
  <AccreditedBy>_IQ2 Calibration Laboratory</AccreditedBy>
  <CalibrationLabel>_N-32768</CalibrationLabel>
  <DateOfCalibration>_2010-01-01</DateOfCalibration>
  <SetupDescription>_Unknown</SetupDescription>
</PowerAnalyzer>
```

- For multi-node environments: the node quantity needs to be set. An example for a 3 node environment:

```
<Node>
  <Quantity>3</Quantity>
```

If the default port numbers in the PTDaemon script files have been changed, the `listeners.xml` file (in the SERT directory) must be changed accordingly. Also any range settings for the power analyzer can be specified in the `listeners.xml` configuration file.

For each additional power analyzer: Add the following section to the `listeners.xml` and change the default values to match the real test environment (**Note:** Do not forget to change the port number).

```
<listener enabled="true">
  <type>PowerAnalyzerListener</type>
  <classpath>
    <path>lib/ptdaemonClientApi.jar</path>
  </classpath>
  <parameters>
    <parameter name="hostname">localhost</parameter>
    <parameter name="port">8888</parameter>
    <parameter name="current-range">
      <range-set>
        <workloads>Memory</workloads>
        <worklets>Flood.*</worklets>
        <default-range>none</default-range>
      </range-set>
      <range-set>
        <workloads>Memory</workloads>
        <worklets>Capacity.*</worklets>
        <default-range>none</default-range>
      </range-set>
      <range-set>
        <workloads>Storage</workloads>
        <default-range>none</default-range>
      </range-set>
      <range-set>
        <workloads>Idle</workloads>
        <default-range>none</default-range>
      </range-set>
      <range-set>
        <default-range>none</default-range>
        <range level="87.5%">none</range>
        <range level="75%">none</range>
        <range level="62.5%">none</range>
        <range level="50%">none</range>
        <range level="37.5%">none</range>
        <range level="25%">none</range>
        <range level="12.5%">none</range>
      </range-set>
    </parameter>
  </parameters>
</listener>
```

On the system under test, edit the SERT host script file (`serthost.bat/serthost.sh` – both be found in the SERT directory) for the appropriate system configuration. For single runs, the `KEEPALIVE` variable can be cleared; for multiple consecutive runs, it should remain at the default setting `-keepalive`.

Check the following specifications for proper values matching the test system configuration:

```
JAVA = <for a non-default Java Virtual Machine (JVM), change the java command to
the pathname of the java command you want to run>
```

The `serthost.sh/.bat` script files currently both include the default definition:

```
JAVA=java
```

On the system under test, run the `serthost.bat/.sh` script file. On Windows, this should run as an Administrator. On Linux, it should run as root. With Ubuntu (or other Linux distributions where a root login is not normally available), use `"sudo serthost.sh"`.

Check `client-configurations-2.0.xml` is up-to-date, and download the latest version from <https://www.spec.org/sert2/client-configurations-2.0.xml> if necessary and copy to base folder. Compare the `version="YYYYMMDD"` string in the header section of the file with your local copy, where the version string specifies the date this file was last changed in the format year month day, e.g. 20170217.

On the Controller running the Director, edit the SERT configuration file `config-all.xml` (in the SERT directory):

Search for `id="clientConfig"` and replace the string `"defaultConfig"` with the configuration name from `client-configurations-2.0.xml` matching your "processor / OS / JVM / memory-per-client" combination (Use the guidance on the Client Configuration page https://www.spec.org/sert2/SERT-JVM_Options-2.0.html for the correct configuration name.). Chauffeur® picks the correct JVM heap sizes (parameters `-Xms` and `-Xmx`), number of JVMs and Java parameters based on the specifications in `client-configurations-2.0.xml` for the selected reference configuration. The computed values must be used for a valid measurement.

Search for `"diskioFilePaths"` in the `<definitions>` section at the beginning. Edit the following lines:

```
<parameter id="diskioFilePaths">
    <path> [specify pathname of storage test device here]</path>
</parameter>
```

Change/remove/add path names of the storage devices to be tested.

Each path name should be listed in its own `<path>` tag.

Edit the `director.bat/.sh` script files for single runs or the `start_director_multiple.bat/.sh` script files to start the desired number of SERT runs. First, the hostname or IP address must be specified in `director.bat/.sh`, then edit the following line:

```
HOSTS=_hostname_or_IP_of_Host_systems_
```

For multi-SUT environments: Add each SUT IP address (separated by a comma) to the HOST argument.
Note: Do not use a space behind the comma(s). An example for 3 SUTS:
`HOSTS=10.10.10.1,10.10.10.2,10.10.10.3`

On the controller system, call the `director.bat/.sh` script file for a single run or the `start_director_multiple.bat/.sh` script file for multiple consecutive runs.

The duration of the whole test sequence depends on the number of test cases defined above. The result files for each SERT test run (`results.html` and `results.xml`) are stored in a separate directory with a name beginning with `sert-nnnn` e.g. `sert-0000`.

On current releases of the SERT Suite, a typical test pass exercising all worklets (CPU, memory, and Storage I/O) on a typical two-socket server with 16GB or more of memory and at least two on-board storage devices, may take 2 ½ hours. This duration is governed by the amount of hardware present in the SUT, so more richly populated platforms may take longer to execute.

6.2. Generate report files with the reporter scripts

In some cases the user might want to create a new .HTML, .CSV or .txt report from an existing SERT xml output file, for example after editing user-modifiable fields (configuration information in the TestEnvironment section).

In order to re-generate an .html, .csv or .txt report from the raw files the following comment need to be used.

```
reporter.bat [options] (for Windows-based system)
```

```
reporter.sh [options] (for Linux/UNIX-based system)
```

Required option:

```
-r [SERT xml results file]
```

Example: `reporter.bat -a -r results/sert-0002/results.xml`

Additional options:

<code>-a</code>	Generate all report formats (HTML, CSV, and Text) default: generate only HTML output
<code>-c</code>	Generate CSV report files
<code>-o Output</code>	Output file for generated report default: match the filename of the raw file, with a .txt, .csv, or .html extension (to match the report type). May not be used with the -a option
<code>-p</code>	Direct XSL transform (must be used with -x) default: generate a report from the transformed output
<code>-s</code>	Skip validation. Reports will automatically be marked invalid
<code>-t</code>	Plain ASCII text output default: generate HTML output
<code>-x XslFile</code>	Use a non-default XSL file to generate the report

Here are some examples of how to use the reporter scripts for regenerating default report files or for generating special output files:

- regenerate all HTML report files
`reporter.bat -r results\sert-0000\results.xml`
- regenerate all default report files
`reporter.bat -a -r results\sert-0000\results.xml`
- generate special CSV report files
`reporter.bat -s -c -x results\XSL-File\csv-detail.xsl -o results-detail.csv -r results\sert-0000\results.xml`

Additional XSL scripts for generating other CSV report files are included in the `results/XSL-File` folder.

7. General Troubleshooting

There are two mechanisms for obtaining support for the SERT Suite. The SERT Discussion Forum (<https://www.spec.org/forums/index.php>) is monitored by representatives from SPEC and can be used to ask questions, especially for topics that may be useful for other SERT users. For specific issues, open a support ticket with the SERT Support Request Form (<https://www.spec.org/sert/feedback/issuereport.html>). Support questions are handled by volunteers from SPEC member institutions.

7.1. Using the Collector Scripts

The SERT package is distributed with two log collection scripts to assist in packaging up various log files and other critical configuration files for troubleshooting. The collector scripts are intended to be run on both the SUT as well as the controller system.

The two scripts are Operating System-specific and may be found in the base SERT installation directory:

`collectlogfiles.bat` is intended to be executed on a Microsoft Windows Operating System.

`collectlogfiles.sh` is intended to be executed on a Linux/UNIX system.

To avoid collecting non relevant information from previous runs the SERT package includes two additional scripts also to be found in the base SERT installation directory:

`cleanlogfiles.bat` is intended to remove log files from previous runs on a Microsoft Windows Operating System.

`cleanlogfiles.sh` is intended to remove log files from previous runs on a Linux/UNIX system.

It is strongly recommended to execute these scripts each time before starting a new SERT cycle, to ensure only relevant log files from the current cycle are archived.

In order to help SPEC diagnose a failed run, please follow these steps:

1. Ensure the run has completed and the GUI has been stopped on the Controller side.
2. On the SUT, open up a command line window, change directories to the base SERT installation directory, and execute either `collectlogfiles.bat` (for Windows systems) or `collectlogfiles.sh` (for Linux/UNIX systems).

By default, the `collectlogfiles` script only collects configuration and log files. For some types of issues (particularly issues when generating reports) it can be helpful to also include the results from the run. If you would like to include the `results.xml` from the most recent run, please use the `/r` (Windows) or `-r` (other platforms) option, e.g. `collectlogfiles.bat /r`

If either of these script files are executed when the SERT Suite has not yet been executed, when no results have been created or when some other part of the test pass has failed then you may see one or more (up to five) instances of the following message: The system cannot find the file specified.

On non-Windows systems where `bash` is not the default shell, it may be necessary to run `"bash collectlogfiles.sh"`.

3. Once the script completes, navigate to the `SERTlog` subdirectory and copy the latest archive file (.zip for Windows, tar.gz for Linux) to the system for submission to SPEC for analysis. The files will be created in the following format:

`<hostname>_YYYY-MM-DD_HHMM.<zip/tar.gz>` (where YYYY is the year, MM is the month, DD is the day, and HHMM represents the hours and minutes count).

Always ensure the latest log archive file is captured, as a new version will be generated in the `SERTlog` subdirectory every time the `collectlogfiles` script is run on that system.

4. Follow the above procedure for the controller system, ensuring the correct script is executed for the Operating System running on the controller.
5. Use the form on <https://www.spec.org/sert/feedback/issuereport.html> in order to submit the files.

7.2. WARNING/INVALID Messages

7.2.1. Power Analyzer

The SERT report shows a WARNING or INVALID message if errors with the calibration, uncertainty, and voltage thresholds occur. Samples of invalid messages that relate to power analyzer:

- INVALID: samples with unknown uncertainty exceeding the threshold
- INVALID: The voltage reported was above the maximum allowed voltage
- INVALID: The calibration date for the power analyzer is over 1 year before the test date

Please refer to instruction in the Measurement Setup Guide: https://www.spec.org/power/docs/SPEC-Power_Measurement_Setup_Guide.pdf

7.2.2. Coefficient of Variation (CV)

The SERT report shows a WARNING or INVALID message if the results for the same worklet between clients show high variability.

On the **memory worklets**, this usually indicates an unbalanced memory configuration between nodes on a multi-processor system. If channels, speeds, and capacities are not identical on each node, it is unlikely that memory worklets can run successfully. It is also strongly recommended to reboot the SUT in between runs with smaller memory configurations (less than 1GB per HW thread).

WARNING or INVALID messages are expected on the **storage worklets**, if different types of disks are used. If the disks are identical, this message usually indicates inconsistent configuration between disks.

The coefficient of variation (CV) is defined as the ratio of the standard deviation σ to the mean μ :

$$C_v = \frac{\sigma}{\mu}$$

It represents the extent of variability in relation to mean of the population. The Host CV and Client CV are presented as percentage numbers in the SERT report.

The **Host CV** is calculated from all individual node performance "Scores" for the whole set of nodes (population) is shown in the report for each interval. The Host CVs are calculated and displayed for multi node runs only, for single node runs a "0.0%" is displayed.

The Host CV is used by the SERT Suite to identify significant deviance of results of some nodes from the mean. Similar results per node are expected for a homogeneous set of nodes, i.e. the CV should be fairly small. High CV values indicate greatly different results for one or more nodes. CV values above certain thresholds will cause warnings or error messages in the SERT result files, and may lead to a run being invalid and thus unsuitable for submission.

The **Client CV** is calculated from all individual client performance "Scores" for the whole set of clients (JVM instances) including all nodes for multi node runs (population) is shown in the SERT report for each interval.

The CV is used by the SERT Suite to identify significant deviance of results of some clients from the mean. Typically similar results per client are expected, i.e. the CV should be fairly small. High CV values indicate greatly different results for one or more clients. For unbalanced configurations, e.g. different types of storage devices (HDD and SSD) or dissimilar amounts of memory attached to different processors, high CV values are "normal". CV values above certain thresholds will cause warnings or error messages in the SERT result files, and may also lead to a run being invalid and thus unsuitable for submission. Warnings can be ignored for unbalanced configurations as high CV values are expected in this case.

7.2.3. Transactions per second was xx% of target

The following values in the config-all.xml file may be set to any integer between 1 and 10 to provide additional warmup time to allow systems to reach steady state before measurements start. This should help in cases where runs are invalid due to 100% throughput being too high or too low, e.g. INVALID: Sequential worklet, interval 100%: Transactions per second was 104.7% of target (threshold is at most 104.0%).

- `<interval-count id="cpuWarmupIntervalCount">3</interval-count>`
- `<interval-count id="memCapacityWarmupIntervalCount">1</interval-count>`
- `<interval-count id="storageWarmupIntervalCount">3</interval-count>`
- `<interval-count id="hybridWarmupIntervalCount">3</interval-count>`